

GROUP **PCO**
SNACKFOOD SOLUTIONS



FIRST CHOICE

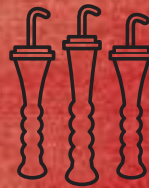
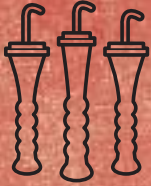

TABLE OF CONTENTS

IMPRINT 2

THE PCO GROUP 3

Your first choice, your contact persons	4
Project partner	6
Your product selection	8
Partner for movie theaters	10
Partner for the movie industry	12
Partner for wholesale and retail	14
Partner for technical service	15
We are proud of it	16



POPCORN 17

What you should know about Popcorn	18-19
How does a Popcorn machine work	20
Popcorn warmers	21
Kettle Popcorn	22-23
Popcorn corn, sugar and salt	24
Popcorn oil	25
Popcorn bags	26
Popcorn tubs	27
Folding boxes and trays	28-30
Popcorn poly bags, storage bags	30
Private Label Popcorn packaging	31
Popcorn machines	32-39
Caramelizers and Coaters	40-41
Oil pumps, Bag in the box,	
Heating blade, Butter dispenser	42
Warmers	43-46
Open warmer	46
Accessories and advertising material	47
Kernel Season's	48



NACHOS & DIPS 49

The best solution for everyone	50
Nachos & Dips combos	51
Nachos & Dips	52-55
Jalapeño Peppers	55
Ricos Cheese-Dip	56
Nacho trays	57-58
Private Label	59
Open warmer	59
Nacho warmers	60-61
Dip dispenser	61
Salsa pumps	62
Jalapeño coolers	62
Nachos island	62-63
Accessories	63-64
Advertising material	64



ICEKING SLUSHY 65

IceKing is more	66
IceKing slushy sirup	67
IceKing slushy machines and base	68
IceKing slushy cups and flutes	69
Accessories	70-71
Advertising material	72-73
IceKing slushy raffle promotions	73
IceKing shake	74-75
IceKing lemonade	76



PICK & MIX 77

Pick & Mix stands	78-81
Pick & Mix sweets	82-85
Pick & Mix accessories	86
Movie Mix	87
Confectionary	88-89
Lollipops	90



SNACKS 91

Popcorn, Nachos, Cotton Candy	92
Popcorn Company	93
Pop'Box: Popcorn for the microwave	94-95
Premium Choco Popcorn	96-97
Crunchy Popcorn	98-99
Finest specialty Popcorn,	
Cinema Popcorn	100-101
Season Snacks	101-103
Fun-Kicker: for all soccer fans	103
Vic, the Viking Popcorn & Cotton Candy	104
Maya, the Bee Popcorn & Cotton Candy	105
Durable Cotton Candy	106
Organic range	107
Nachos & Dips: simply delicious	108-109
Private Label	110



DRINKING CUPS & STRAWS 111

IML-cups: What is IML?	112
Movie promotions and Private Label	113
Coca-Cola and Pepsi drinking cups	114
Lids and drinking straws	115
Transparent drinking cups and mugs	116
Hot drink cups	117
Cup dispensers	118



MOVIE PROMOTIONS 119

Meet your movie heroes	120
Menu-trays	121
Top the PET bottles, ever popular	122
Well packaged: bags, boxes, tubs	123
Our IML-cups: more than just a cup!	124
Topper on top	125
Premiums: love at first sight	126



HYGIENE ARTICLES 127

Hygiene dispensers, stainless steel	128-129
Hygiene dispensers, plastic	129-132
Toilet paper	133
Paper towels	133
Washing lotion	134
Air freshener cans, hygiene bags	135
Dishwashing detergents	135-136
Cleaning agents	136-137
Trash bags	138



3D-GLASSES & CHILD SEATS 139

Welcome to the 3rd dimension	140-142
Sit higher, see more	143-144



HOMBRE NUTS 145

The crispy delight	146
--------------------	-----



ORDER INFORMATION 147

Website, newsletter	148
---------------------	-----

Imprint:

PCO Group GmbH
info@pco-group.com
www.pco-group.com

Holmer Berg 15-17
D-23942 Dassow
Telephone: +49 38826 829 0
Fax: +49 38826 829 20

Hupfleitenweg 10
D-82467 Garmisch-Partenkirchen
Telephone: +49 8821 9501 0
Fax: +49 8821 9501 99

General Managers: Bernhard Wettlaufer and Stefan Lemke
Registry court Schwerin, HRB 8950
Sales tax identification number: DE 814568064.4

4. Edition 05.2016 | English

Texts: PCO

Graphics: Ulrike Wiesner and Katrin Oppenrieder

Pictures: PCO, Bergmann Fotografie, Armağan Akinci, Fotolia (p. 143, 147), Cretors, Gold Medal, Ricos, Business Russia, Multikino, Carolin Friese

Illustrations, Icons: Agentur zur Schönen Gärtnerin

Print: Kriechbaumer Druck GmbH & Co. KG

All rights reserved. Subject to changes and errors.

PCO Group
- your partner
- your choice

Whether it's for movie theaters, arenas, bowling alleys, video stores, indoor playgrounds, leisure parks, fairground businesses or the catering trade – we are your partner; anywhere you'll find snack food available through counter sales. Are you a film distributor? We have experience with licensed products. Are you active in retail? Then you can benefit from our broad range of products.



Your first choice – PCO Group

The know-how of PCO Group is the result of successful work since the 80s. Our principles are simple and clear: **the highest quality, the most reliability and best service.**

Our operational business is steered by two company headquarters in Dassow (near Hamburg) and Garmisch-Partenkirchen (near Munich). We are also present in various European countries and in the USA.

Germany

Contact Person: Marc Wieschendorf
 PCO Group GmbH
 Holmer Berg 15-17
 D-23942 Dassow
 Telephone: +49 38826 829 35
 Fax: +49 38826 829 11
 marc.wieschendorf@pco-group.com
 www.pco-group.com

Contact Persons: Dietmar Wellenstein and Heide Greinsperger
 PCO Group GmbH
 Hupfleitenweg 10
 D-82467 Garmisch-Partenkirchen
 Telephone: +49 8821 9501 71 (Wellenstein)
 Telephone: +49 8821 9501 28 (Greinsperger)
 Fax: +49 8821 9501 99
 dietmar.wellenstein@pco-group.com
 heide.greinsperger@pco-group.com
 www.pco-group.com

Poland, Baltic States, Czech Republic

Contact Person: Rafael Wisniewski
 PCO Group Sp. z o. o.
 ul. Polna 13A
 PL-76-020 Bobolice
 Telephone: +48 94 347 56 10
 Fax: +48 94 347 56 11
 r.wisniewski@pco-group.pl
 www.pco-group.com/pl

Hungary, Serbia, Croatia, Slovenia, Slovakia, Czech Republic, Bosnia-Herzegovina, Montenegro

Contact Person: Zsolt Rati
 PCO Group Magyarország Kft.
 Ipari park utca 10
 HU-1044 Budapest
 Telephone: +36 1 417 31 87
 Fax: +36 1 417 31 14
 zsolt.rati@pco-group.hu
 www.pco-group.com/hu

Romania, Bulgaria, Moldova

Contact Person: Antim Mogoş
 PCO Group Romania SRL
 Str. Brasov Nr. 9, Bl. E14, Et. 1, Ap. 8
 RO-061441, Sector 6, Bucureşti
 Telephone: +40.31.425.00.72
 Fax: +40.31.425.00.74
 romania@pco-group.com
 www.pco-group.com/ro

Belgium, France, Luxembourg

PCO Group Belgium
 since 2008

UK, Ireland

PCO Group UK Ltd.
 since 2014

USA

POP BOX LLC.
 since 2012
 SNAPCO LLC.
 since 2008

Latin America

Snapco LLC
 since 2008

Spain, Portugal

PCO Group España
 since 2012

Germany

PCO Group GmbH
 since 2006 (Popcorn Company since 1988)
 PCO Group GmbH
 since 2006 (Octagon since 1988)

Italy

PCO Group Italy
 since 2015



Netherlands , Belgium, France, Luxembourg

Contact Person: Michael Dekker
 PCO Nederland B.V.
 Larserpootweg 4
 8218 NK Lelystad
 Telephone: +31 36 711 34 22
 Fax: +31 36 711 34 23
 nederland@pco-group.com
 www.pco-group.com/nl

Turkey

Contact Person: Zafer Dülger
 PCO Group Gida Ltd.
 Ethem Efendi Cad.Canakci Apt.No:64 Daire:9
 Erenkoy/Kadikoy - Istanbul 34738
 Telephone: +90 216 410 37 01
 Fax: +90 216 410 37 02
 zafer.dulger@pco-group.com
 www.pco-group.com/tr

Spain, Portugal

Contact Person: Marisol Blanco and Monica Roca
 PCO Group España
 Pallars 85-91, 6º, 5ª
 E-08010 Barcelona
 Telephone: +34 93 231 2557
 Fax: +34 93 520 7600
 espana@pco-group.com
 www.pco-group.com/es

Italy

Contact Person: Olaf Kasal
 PCO Group Italy
 via Pillhof 105
 I-39057 Frangarto (BZ)
 Telephone: +39 0471 188116 0
 Fax: +39 0471 188116 6
 olaf.kasal@pco-group.com
 www.pco-group.com/it

UK, Ireland

Contact Person: Joe Kelly
 PCO Group UK Ltd.
 Park View Business Centre
 Combermere, Shropshire
 SY13 4AL
 Telephone: +44 1270 781188
 joe.kelly@pco-group.com
 www.pco-group.com

USA

POP BOX LLC.
 2638 Delta Lane
 USA Elk Grove Village, IL 60007
 Telephone: +1 630-509-2281 ext. 144
 Fax: +1 630-509-2268
 info@pop-box.com
 www.pop-box.com

SNAPCO LLC.

Contact Person: Bill Howard
 3760 Calle Tecate Suite B
 USA Camarillo, CA 93012
 Telephone: +1 805 200 8600
 bill@snapcreative.com
 www.snapcollc.com

In many other countries we cooperate with selected partners in order to be able to serve you perfectly well **around the world.**

Take advantage of our presence!

Netherlands

PCO Nederland B.V.
 since 2008

Poland, Baltic States, Czech Republic

PCO Group Sp. z o. o.
 since 2006 (Popcorn Company since 2001)

Romania, Bulgaria, Moldova

PCO Group Romania SRL
 since 2007

Turkey

PCO Group Gida Ltd.
 since 2008

Asia

Snapco LLC
 since 2008

Hungary, Serbia, Croatia, Slovenia, Slovakia, Czech Republic, Bosnia-Herzegovina, Montenegro, Macedonia, Greece, Albania

PCO Group Magyarország Kft.
 since 2006 (Popcorn Company since 2003)

Australia

Snapco LLC
 since 2008

Project partner – **PCO Group**

Are you planning a new and innovative product? We will assist you with concept and development.

Are you looking for the right packaging for your product? We have the know-how and the ideal partners to work with you on the development of the perfect solution. We will be with you from idea to launch.

Are you looking for new distribution channels for a product? We have experience in opening them up. We have the right contacts and can get your product tested and launched in this particular market segment. And we have the logistics to get your product distributed in the markets.

Are you looking for new, high-quality displays or a fresh, stylish design for your shop? We have a large selection of display solutions to choose from. You don't see the perfect layout for you? We can get together with you and our manufacturer to find the perfect solution.

Use our extensive know-how!





Your product selection at **PCO** Group

You can find detailed information about our products here in our catalogue, on the international website www.pco-group.com, in our online shop – and of course, our expert staff will be pleased to advise you on the phone or in person.

Our **Popcorn range** encompasses machines from famous manufacturers in all dimensions, high-quality ingredients (Popcorn corn, Popcorn oil, sugar & salt) and attractive packaging.

Our **Nacho range** includes Nacho warmers, dispensers for dips, tasty Nachos, Salsa- and Cheese-Dips, Guacamole and Sour-Cream as well as Nacho trays.

Our **Snack range** encompasses nibbles like our popular Popcorn specialties, Nachos & Dips as well as durable Cotton Candy.

With **IceKing slushy** we offer everything a professional slush range needs: high-quality syrup, slushy machines as well as funny flutes with matching drinking straws.

Our **Pick & Mix** combines elegant design with top-quality sweets. Furthermore our **Movie Mix** offers five pre-packed mixes to suit every palate. For more refined tastes our **Confectionary** section has customisable jars filled with tasty snacks.

Our **Promotion range** comprises different Popcorn packaging in various dimensions, drinking cups and special premium articles (toppers, drinking straws, keychains etc.) with current blockbuster movie themes.

Even in the field of 3D we will supply you with new and recycled **3D-glasses**.

Our **Drinking cup range** includes cups for hot and cold drinks, lids, drinking straws as well as our reusable IML cups with movie themes.

Our **Hygiene and Cleaning range** includes hygiene dispensers, consumables and cleaning agents.

Take advantage of our broad product range!

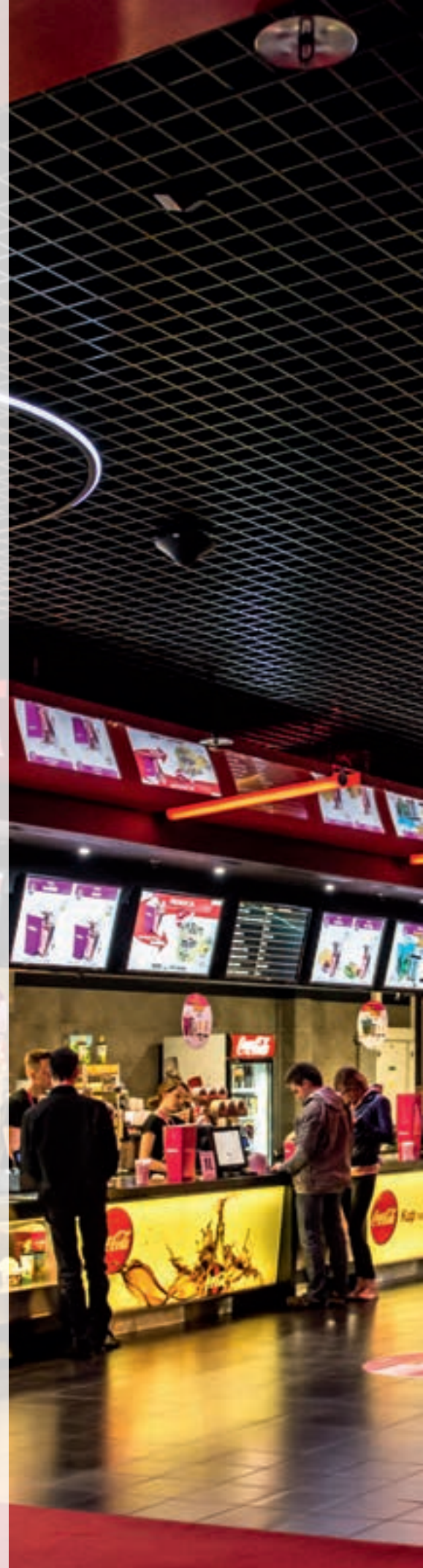



Partner for movie theaters – **PCO Group**

Our team is familiar with all aspects of the cinema industry. We can tailor our services precisely to the needs of each individual customer – from repertory cinemas to multiplex and international movie theater chains.

By planning ahead, the inventory is always adapted to the anticipated need in the market. Thus we can guarantee deliveries even at any time of great demand. We deliver direct to your storage facility – and at a specific times, if required.

Benefit from our experience by detailed conversations – on the phone or in person.

Regular internal and external quality checks guarantee highest quality standards. The external tests are carried out by the food labs SGS and Labor Dr. Böhm.

Take advantage of our expertise!

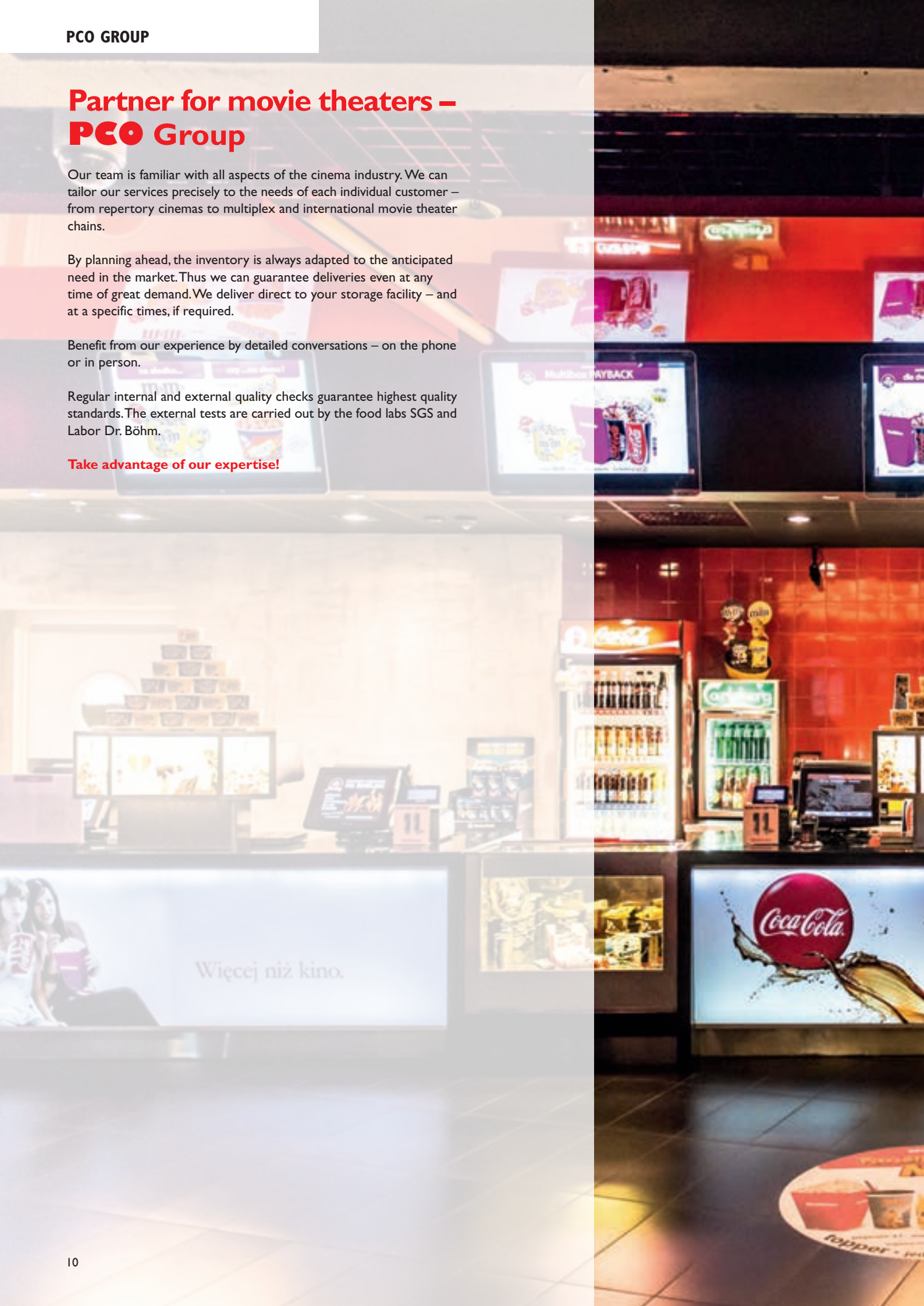



Partner for the movie industry – PCO Group

The presence in the cinema foyer is an important part in the promotion of a new movie. The attractive appearance fills moviegoers with eager anticipation. PCO supports all major studios as an experienced partner with worldwide or local campaigns.

Different Popcorn and beverage packaging and a broad range of movie branded premiums make for repeated cinema visits. The high-quality products are taken home as a reminder not to miss the upcoming movie and they have fond memories of their visit.

A worldwide customer base and focused advertising, like newsletter, personalized self-mailers and ads assure a broad distribution of the offered products. As the promotional products are simply delivered with the regular orders, PCO can assure promotions in many cinemas.

Also individual requirements of the studios can be covered with a diversified experience in product development.

Take advantage of our experience!





Partner for wholesale and retail – PCO Group

In the German food industry we are holding the leading position in Popcorn and Cotton Candy for years. Internationally established super-market chains, as well as kiosks, video stores and gas stations are among our customers. All products can also be exported worldwide. As an **IFS and organically certified company**, we meet the highest quality standards. Of course, all products can also be produced with a Private Label.

What you can expect from us:

- highest quality standards for our products
- expertise in the export field
- excellent service with high customer orientation

Popcorn

At PCO you can get both sweet and salted Popcorn and our top products Toffee Popcorn, Chocolate Popcorn, Organic Popcorn and Popcorn for the microwave in the patented folding box. Our Premium Choco Popcorn is pure de luxe temptation: the finest Toffee Popcorn coated with exquisite chocolate in different varieties.

Nachos & Dips

With our Nachos you offer your customers a real trendy snack. The spicy corn chips are ideally complemented by our Salsa-Dips. Just as popular is our Cheese-Dip, which is also suitable for microwaving. The range of Dips is rounded off with Guacamole and Sour-Cream. Nachos and Dips are available both individually as well as in combined packages.

Cotton Candy

Cotton Candy is popular at all funfairs – but has to be consumed immediately. From PCO, durable Cotton Candy is available in cups or tubs for home.

Take advantage of our experience in product development!



Partner for technical service – PCO Group

Everything covered, everything tested?

Everything's quite simple!

Did you know that DIN VDE 0701-0702 stipulates that inspections must be conducted every 24 months for machines that are permanently fixed, and every year for mobile devices – including proper documentation?

Security for your devices

This includes, among others, visual inspection, inspection of the earth wire, measurement of isolation resistance and earth wire current, measurement of the touch current, verification of the secure separation from the supply current (SELV and PELV) as well as the effectiveness of additional security installations, the final inspection of the labels, functional assessment, evaluation, appraisal, documentation, and suitable measuring devices.

Sounds complicated? Indeed it is – but not for our customers! Our highly qualified team of technicians and electricians take care of it for you – competently, quickly, and reliably.

Take advantage of our safety consciousness!



We are proud of it

At PCO you will find the largest selection of machines – we currently have over 5,300 devices in stock – and competent consultation as early in the planning phase.

- We have over 57,000 replacement parts for the equipment we sell ready for you.
- Your replacement order is shipped immediately: upon ordering by 1:00 p.m. you will receive your order on the next business day upon request, for articles that are on stock.
- Having technical issues? Our highly qualified technicians and master electricians are standing by with professional telephone support – or provide guaranteed fast, competent solutions for repairs, service, or maintenance with our on-site service.

A strong team

The PCO technicians and our educated master electricians are working for you every day. They are also available by phone, of course.

Take advantage of our service!

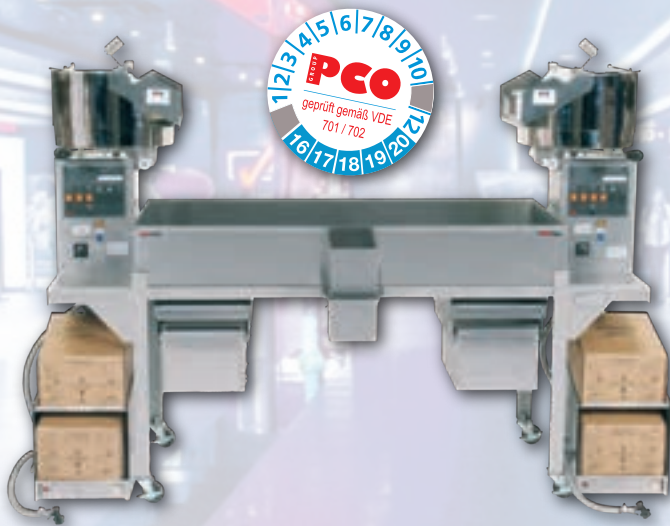

All devices tested by us receive the PCOVDE safety seal



We are there when you need us.

Fresh Popcorn for crisp sales

Popcorn is and will remain the leader among movie theater snacks. It is easy to produce and has enjoyed great popularity for decades. And of course it has already conquered many other recreational areas.

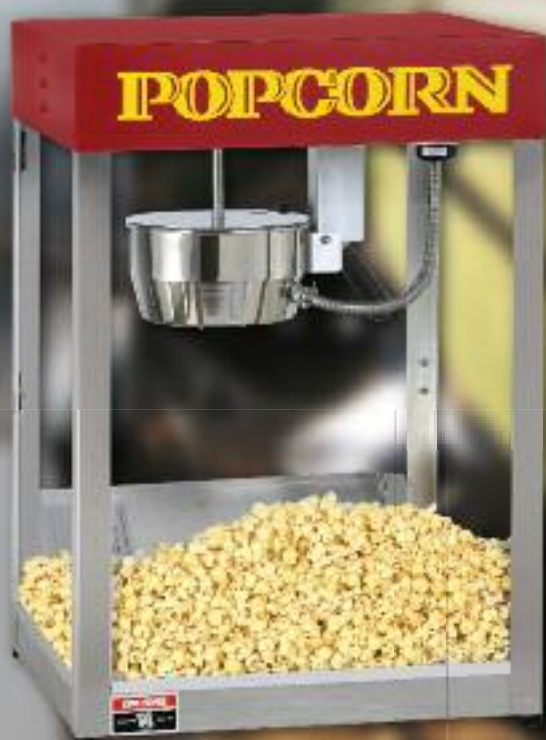

What you should know about Popcorn

How does corn become Popcorn?

When heated, the moisture inside the corn kernel expands until the hard shell cannot hold it anymore and bursts. In a split second, the heated starch swells under the pressure of water vapor and exits in the form of a foamy structure. It loses temperature and solidifies immediately through rapid cooling. So Popcorn is a small frozen explosion.



Corn varieties

For the production of Popcorn you need a special popping corn. This special corn used for Popcorn is available in two varieties: Butterfly and Mushroom. The names derive from the shapes of the popped corn kernels.

Mushroom



The volume test

Which type of corn has a higher volume? The one that looks like a mushroom when it pops, or the one that resembles a butterfly?

You'll never guess!

$1 + 1 = 2$? Not with corn or Popcorn.

The test is conducted in an MR-16 MWVT (metric weight volume tester). The exact same quantity of corn is measured in this device (250 g).



Butterfly



The test result

Here are the results. How can that be? The individual fluff looks a lot bigger in the mushroom corn.

It's quite simple: The Americans count the kernels per 10 g. For mushroom corn this equates to 49, and 65 kernels for butterfly, or 16 kernels more.

Mushroom kernels also lie closer together and butterfly kernels expand more, due to their shape.



average
mushroom corn
e.g. PCO mushroom corn

higher volume
butterfly corn
e.g. PCO Popgold

achieves
40%
more volume
in the test

What does that mean for YOU?

This means that from the same amount of corn, you receive **14 x 3L bags of mushroom corn,**



but **19.3 x 3L bags of butterfly Popcorn.**



Can you try it out for yourself? But of course! Simply pop the exact same weight in kernels and fill up! For our test we used 1.2 kg mushroom corn and 1.2 kg butterfly corn in a 48 oz machine. Of course, you can use any quantity you wish, depending on your device. Just please remember to weigh the kernels!

Some promise big fluffs, but the Popcorn's volume is low! The fact is that butterfly puffs look smaller (we believe), but are almost 40 % larger and taste better (we believe). Mushroom puffs look cool (we believe), are firmer to the bite, but possess less volume.

Of course you will receive the ideal recipe from us for each type of corn – the perfect recommended serving for consistently delicious taste.

We are also happy to conduct the volume test on site for you. Simply give us a call.

The regionality principle

And what do you think about the environment? We feel that Popcorn does not belong in plastic sacks. Corn is a wonderful natural product, should be packed in an environmentally friendly way, and should reach both us and you via the shortest possible route. Over 90 % of our corn comes from our neighbours in southern France, after all.

Our contact partners Uwe Bergmann (+49 038826 829 10) and Maria Winkler-Svejkovsky (+49 08821 9501 21) are available for any questions about corn, the corn test, and regionality. Or send us an email.

How does a Popcorn machine work?

The machine has a tilting kettle that is heated electrically, where the corn is heated in no time to 220°C. The kettle is filled with corn, oil and sugar or salt. In the kettle there is an agitator that constantly stirs the ingredients. This way the heat and the ingredients are distributed evenly. The popped kernels push open the light cover and the finished Popcorn drops into the heated cabinet.



Popcorn machines in different sizes and with different features

The possible applications of Popcorn machines are very diverse and so are the models and features of Popcorn machines. The so-called counter models are equipped with a glass-enclosed stainless steel cabinet and the kettle for the production of Popcorn is mounted in the top of the cabinet. The presentation of the Popcorn directly in the machine reinforces the impression of particularly fresh Popcorn among customers. Popcorn machines of the middle category may already be equipped with an oil pump.

The larger cabinet Popcorn machines are equipped not only with a larger kettle and a spacious cabinet, but also with a grease and active carbon filter system. Optionally, there is a suitable base for all the devices. Here ingredients such as corn and sugar can be stored in addition to the oil pump.

For the production of Popcorn in large quantities an industrial machine is recommended. The kettles are not mounted in a cabinet, but on a production table. Equipped with one or two production heads, they are set up in a separate "Popcorn kitchen". The finished Popcorn is heated in special warmers and presented at the counter.

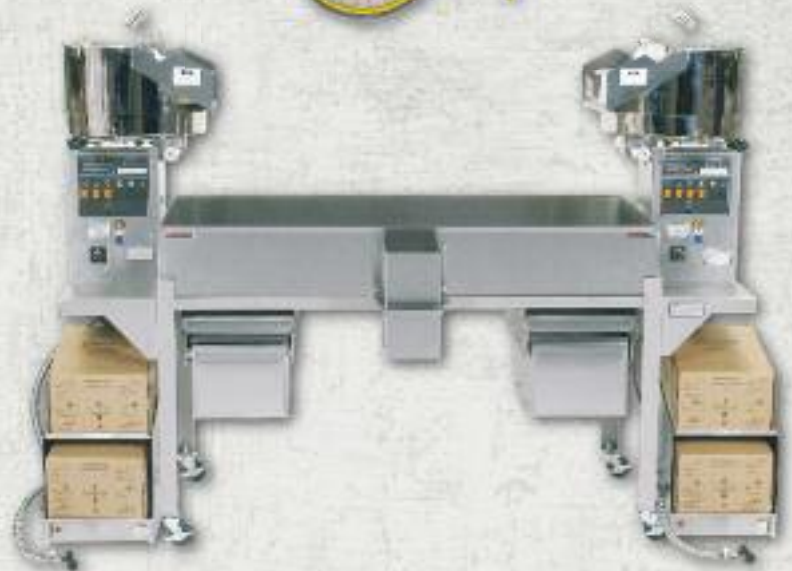

Popcorn warmers

The wide range of Popcorn warmers provides the right solution for each counter. Cabinet warmers find their place on the counter. The cabinet is equipped with shelves. Here filled Popcorn bags or tubs are heated and stand ready for sale.



For larger quantities, suitable warmers are built into the counters. These built-in warmers are available in various sizes and designs. In the warmers, mirrors create the illusion that there is an "unending" supply of Popcorn stored. The installed warmers keep the loose Popcorn warm and it can then be filled for selling. For greater needs there are additional floor to ceiling warmers in different designs. The right solution is available for every customer.



Winter Wonderland KETTLE POPCORN

Fresh from your Popcorn kettle



Kettle Popcorn Mix Winter Wonderland with Christmas spices cinnamon and clove, Ginger, star anise, nutmeg, coriander ... start your own gourmet popcorn business today.

You can serve the finished, fresh-roasted kettle Popcorn in attractive folding boxes with embossed designs and spot varnish decorations.



Best Taste – Simple Preparation

Our kettle Popcorn is easy to prepare in your own Popcorn machine; you'll simply use our Kettle Popcorn Mix instead of sugar.

Caramel KETTLE POPCORN

Fresh from your Popcorn kettle

With our gourmet caramel blend, you will enjoy crispy, thickly coated toffee Popcorn, rounded off by a fine hint of butter

You can purchase folding containers in size 1 (150 x 100 x 60 mm) for approx. 75 g, 2 (150 x 100 x 100 mm) for approx. 125 g and 3 (150 x 100 x 140 mm) for approx. 200 g of Popcorn.



Ready to Go

Are you interested in our product, but don't want to prepare it yourself? Of course, you can also purchase ready-made containers of kettle Popcorn from us in various sizes.

Popcorn

A | Popgold Mushroom
22.68 kg bag
article no. 1110009

Popgold Butterfly
22.68 kg bag
article no. 1110010



Sugar and salt

A | Popgold Mushroom / Butterfly

B | Popcorn sugar

B | Popcorn sugar
25 kg bag
article no. 1130003

C | Cretors Popcorn salt
22.68 kg carton
article no. 1130045

D | Cretors Popcorn salt
12 x 907 g carton
article no. 1130147
1 x 907 kg carton
article no. 1130148



E | Special salt with butter flavor
6 kg bucket
article no. 1130005
800 g cup
article no. 1130006

C | Cretors Popcorn salt

D | Cretors Popcorn salt

F | Kettle Popcorn Mix
10 kg bag
Caramel
Article no. 1130153
Winter Wonderland
Article no. 1130154



G | Caramel Popcorn Mix
for production in the caramelizer
(see p. 40-41)
12 x 22 oz. bags / carton
article no. 1130026

E | Special salt with butter flavor

F | Kettle Popcorn Mix

H | Chocolate Popcorn Mix
for production in the caramelizer
(see p. 40-41)
12 x 22 oz. bags / carton
article no. 1130042

Basic Popcorn Mix
(without picture)
for production in the caramelizer
(see p. 40-41)
12 x 22 oz. bags / carton
article no. 1130111



G | Caramel Popcorn Mix

H | Chocolate Popcorn Mix

Popcorn oil



I | Special oil, semi-liquid, 15 kg



J | Coconut oil, sweet, 15 kg

**I | Special oil, semi-liquid,
Bag in the Box**
15 kg carton
article no. I I 20001

**J | Coconut oil, sweet,
Bag in the Box**
15 kg carton
article no. I I 20003



K | Coconut oil, salty, 15 kg



L | Popgenuss, 15 kg

**K | Coconut oil, salty,
Bag in the Box**
15 kg carton
article no. I I 20004

**L | Popgenuss,
Bag in the Box**
15 kg carton
article no. I I 20024



M | Special oil, semi-liquid, 20 L



N | Coconut oil, sweet, 20 L

M | Special oil, semi-liquid
20 L bucket
article no. I I 20008

N | Coconut oil, sweet
20 L bucket
article no. I I 20019



O | Coconut oil, salty, 20 L



P | Popgenuss, 20 kg

O | Coconut oil, salty
20 L bucket
article no. I I 20018

P | Popgenuss
20 kg bucket
article no. I I 20023



Q | Popgenuss, 4.5 kg + Dispenser



R | Popcorn oil Poppy

Q | Popgenuss
4.5 kg canister
article no. I I 20027

Dispenser
1 pc
article no. I 300001

R | Popcorn oil Poppy
40 x 250 g / carton
article no. I I 20021

Popcorn bags

- A | Popcorn bags**
Poppy red-yellow, size 1
 1,000 pcs / carton
 article no. 1210033
- Poppy red-yellow, size 2**
 1,000 pcs / carton
 article no. 1210034
- Poppy red-yellow, size 3**
 500 pcs / carton
 article no. 1210035
- Poppy red-yellow, size 4**
 500 pcs / carton
 article no. 1210036



A | Popcorn bags Poppy red-yellow



B | Popcorn bags Poppy Eco

- B | Popcorn bags**
Poppy Eco, size 1
 1,000 pcs / carton
 article no. 1210005
- Poppy Eco, size 2**
 1,000 pcs / carton
 article no. 1210006
- Poppy Eco, size 3**
 500 pcs / carton
 article no. 1210007
- Poppy Eco, size 4**
 500 pcs / carton
 article no. 1210008



C | Popcorn bags Art in the Cinema



D | Popcorn bags Art in the Cinema

- C | Popcorn bags**
Art in the Cinema, size 1
 1,000 pcs / carton
 article no. 1210037

- D | Popcorn bags**
Art in the Cinema, size 2
 1,000 pcs / carton
 article no. 1210038

- E | Popcorn bags**
Art in the Cinema, size 3
 500 pcs / carton
 article no. 1210039

- F | Popcorn bags**
Art in the Cinema, size 4
 500 pcs / carton
 article no. 1210040



E | Popcorn bags Art in the Cinema



F | Popcorn bags Art in the Cinema

Popcorn tubs

G | Popcorn tubs
Poppy red-yellow, size 1
 500 pcs / carton
 article no. 1220012

Poppy red-yellow, size 2
 600 pcs / carton
 article no. 1220030

Poppy red-yellow, size 3
 300 pcs / carton
 article no. 1220014

Poppy red-yellow, size 4
 300 pcs / carton
 article no. 1220015

Poppy red-yellow, size 5
 150 pcs / carton
 article no. 1220016

H | Popcorn tubs
Art in the Cinema, size 1
 500 pcs / carton
 article no. 1220023

I | Popcorn tubs
Art in the Cinema, size 2
 500 pcs / carton
 article no. 1220024

Dome-lids for
Popcorn tubs size 2
 500 pcs / carton
 article no. 1220027

J | Popcorn tubs
Art in the Cinema, size 3
 300 pcs / carton
 article no. 1220025

Dome-lids for
Popcorn tubs size 3 and 4
 150 pcs / carton
 article no. 1220028

K | Popcorn tubs
Art in the Cinema, size 4
 150 pcs / carton
 article no. 1220026

L | Popcorn tubs
Art in the Cinema, size 5
 180 pcs / carton
 article no. 1220006

Dome-lids for
Popcorn tubs size 5
 180 pcs / carton
 article no. 1220029



G | Popcorn tubs Poppy red-yellow



H | Popcorn tubs Art in the Cinema



I | Popcorn tubs Art in the Cinema



J | Popcorn tubs Art in the Cinema



K | Popcorn tubs Art in the Cinema



L | Popcorn tubs Art in the Cinema

Folding boxes and trays

A | Folding boxes
Art in the Cinema, size 1
 300 pcs / carton
 article no. 1230025

Folding boxes
Art in the Cinema, size 2
 300 pcs / carton
 article no. 1230026

Folding boxes
Art in the Cinema, size 3
 300 pcs / carton
 article no. 1230027

Folding boxes
Art in the Cinema, size 4
 300 pcs / carton
 article no. 1230028

Folding boxes
Art in the Cinema, size 5
 300 pcs / carton
 article no. 1230029



A | Folding boxes Art in the Cinema

B | Folding boxes
Poppy red-yellow, size 1
 500 pcs / carton
 article no. 1230012

Poppy red-yellow, size 2
 500 pcs / carton
 article no. 1230013

Poppy red-yellow, size 3
 300 pcs / carton
 article no. 1230014

Poppy red-yellow, size 4
 150 pcs / carton
 article no. 1230015



B | Folding boxes Poppy red-yellow

C | Speed Pack Poppy red-yellow
 200 pcs / carton
 article no. 1230005

D | Kids-Tray Poppy red-yellow
 250 pcs / carton
 article no. 1230016



C | Speed Pack Poppy red-yellow



D | Kids-Tray Poppy red-yellow

- E | Folding boxes Kettle Popcorn
Winter Wonderland, size 1**
150 x 100 x 60 mm
300 pcs / carton
article no. 1230043

Winter Wonderland, size 2
150 x 100 x 100 mm
300 pcs / carton
article no. 1230044

Winter Wonderland, size 3
150 x 100 x 140 mm
300 pcs / carton
article no. 1230045



E | Folding boxes Kettle Popcorn, Winter Wonderland

- F | Folding boxes Kettle Popcorn
Caramel, size 1**
150 x 100 x 60 mm
300 pcs / carton
article no. 1230040

**Folding boxes Kettle Popcorn
Caramel, size 2**
150 x 100 x 100 mm
300 pcs / carton
article no. 1230041

**Folding boxes Kettle Popcorn
Caramel, size 3**
150 x 100 x 140 mm
300 pcs / carton
article no. 1230042



F | Folding boxes Kettle Popcorn, Caramel

All set

Do you like the product, but don't want to prepare it yourself?

We can always provide you with ready-made kettle corn, of course:

Ready-made Kettle Popcorn
(no image)

6.5 kg bag

Winter wonderland
article no. 8150001

Caramel
article no. 8150002

A | Kids-Menu-Tray

250 pcs / carton
(Design example “Maya the Bee”)
article no. 1250266

We also regularly offer the Kids-Menu-Tray with current blockbuster themes. Detailed information can be found in the chapter about Movie promotions starting on page 119.



A | Kids-Menu-Tray

B | Carry-out-Tray

250 pcs / carton
article no. 1230009



B | Carry-out-Tray

C | Kids-Tray with carrying handle

250 pcs / carton
article no. 1230008

D | Maxi-Tray

70 pcs / carton
article no. 1240054

Popcorn poly bags

E | Poly bags, size 1

for approx. 50 g Popcorn
2,000 pcs / carton
article no. 1290018

Poly bags, size 2

for approx. 100 g Popcorn
1,000 pcs / carton
article no. 1290019

Poly bags, size 3

for approx. 250 g Popcorn
1,000 pcs / carton
article no. 1290020

Clip ties

1,000 pcs / carton
article no. 1290014



C | Kids-Tray with carrying handle



D | Maxi-Tray

Storage bags

F | Storage bags, white, 110 L

100 pcs / carton
article no. 1290016

Storage bags, red, 110 L

100 pcs / carton
article no. 1290017

Storage bucket, 33 L

(without picture)
article no. 1290001



E | Poly bags



F | Storage bags

Private Label Popcorn packaging

Of course, we can produce all the packaging shown with your individual design. On request, we will send you an individual offer. Here are some examples.



Equipment

Popcorn machines 4 oz – 8 oz

A | Fun Popper 4 oz (Gold Medal)

with heated bottom plate and interior lighting

Capacity: approx. 50 L / Hr.

230 V; 4.5 A; 688 W

Dimensions: D: 41 W: 41 H: 63.2 cm

article no. **7B0001**



B | Cart for Fun Popper 4 oz (Gold Medal)

Dimensions: D: 41.5 W: 41.5 H: 86.5 cm

article no. **7B0031**

C | Titan 6 oz (Gold Medal)

with heated bottom plate and heat lamp

Capacity: approx. 65 L / Hr.

230 V; 5 A; 1,197 W

Dimensions: D: 36 W: 51 H: 72 cm

article no. **7B0004**

A | Fun Popper 4 oz

B | Cart for Fun Popper 4 oz

D | Goldrush 6 oz (Cretors)

Stainless steel kettle, TÜV/GS tested, with heat lamp and heated bottom plate

Capacity: approx. 65 L / Hr.

230 V; 4.5 A; 1,090 W

Dimensions: T: 38 B: 51 H: 70 cm

article no. **7A0004**

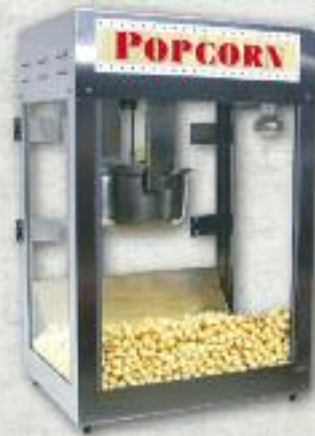

E | Bronco Pop 8 oz (Gold Medal)

with red roof, heat lamp and heated bottom plate

Capacity: approx. 80 L / Hr.

230 V; 14 A; 1,720 W

Dimensions: D: 51 W: 51 H: 102 cm

article no. **7B0057**

C | Titan 6 oz

D | Goldrush 6 oz

F | Euro Pop 8 oz (Gold Medal)

with heat lamp and heated bottom plate

Capacity: approx. 80 L / Hr.

230 V; 8.7 A; 1,050 W

Dimensions: D: 46.5 W: 46.5 H: 74.5 cm

article no. **7B0046**

Cart for Euro Pop 8 oz (Gold Medal)

Dimensions: D: 47 W: 47 H: 75 cm

article no. **7B0045**



E | Bronco Pop 8 oz

F | Euro Pop 8 oz

Popcorn machines 8 oz – 12 oz

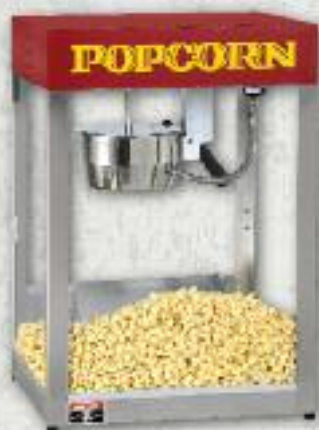

G | T-2000 8 oz



H | Whiz Bang 12 oz

G | T-2000 8 oz (Cretors)

TÜV/GS tested, with heat lamp,
heated bottom plate, stainless steel
kettle

Capacity: approx. 80 L / Hr.

230 V; 5,1 A; 1,325 W

Dimensions: T: 54,5 B: 54,5 H: 77 cm

article no. **7A0009**

H | Whiz Bang 12 oz (Gold Medal)

with stainless steel roof, heat lamp
and heated bottom plate

Capacity: approx. 130 L / Hr.

230 V; 19 A; 2,300 W

Dimensions: D: 71 W: 51 H: 102 cm

article no. **7B0008**



I | Pop Maxx 12 oz



J | T-3000 Plus 12 oz

I | Pop Maxx 12 oz (Gold Medal)

with heated bottom plate
and heat lamp

Capacity: approx. 130 L / Hr.

230 V; 15 A; 1,800 W

Dimensions: D: 51 W: 51 H: 81 cm

article no. **7B0064**

J | T-3000 Plus 12 oz (Cretors)

TÜV/GS tested, with hot air system,
stainless steel kettle,

equipped for oil pump operation

Capacity: approx. 130 L / Hr.

230 V; 7,2 A; 1,800 W

Dimensions: D: 54 W: 61 H: 97 cm

article no. **7A0016**

K | Antik T-3000 Plus 12 oz (Cretors)

TÜV/GS tested, incl. 2 wheel cart,
stainless steel kettle, with hot air
system, equipped for oil pump
operation

Capacity: approx. 130 L / Hr.

230 V; 7,2 A; 1,800 W

Dimensions: D: 76 W: 110 H: 191 cm

article no. **7A0018**



K | Antik T-3000 Plus 12 oz

Popcorn machines 16 oz

A | Econo-Merchant 16 oz (Cretors)

TÜV/GS tested, with hot air system, heat lamp, grease filter, stainless steel kettle, equipped for oil pump operation
Capacity: approx. 170 L / Hr.
230V; 10 A; 2,335 W
Dimensions: D: 58 W: 73 H: 94 cm
article no. 7A0022

Base cabinet Merchant & Econo-Merchant 16 oz (Cretors)

4 wheels, with corn drawer and space for an oil pump
Dimensions: D: 58 W: 73 H: 76 cm
article no. 7A0025



A | Econo-Merchant 16 oz



B | Astro-Pop 16 oz

B | Astro-Pop 16 oz (Gold Medal)

with heated bottom plate, stainless steel kettle, audible warning and interior lighting, equipped for oil pump
Capacity: approx. 170 L / Hr.
230V; 14 A; 3,450 W
Dimensions: D: 72 W: 72 H: 102.6 cm
article no. 7B0013

Base cabinet Astro-Pop 16 oz (Gold Medal)

Stainless steel, flexible storage space
Dimensions: D: 72 W: 72 H: 81 cm
article no. 7B0035

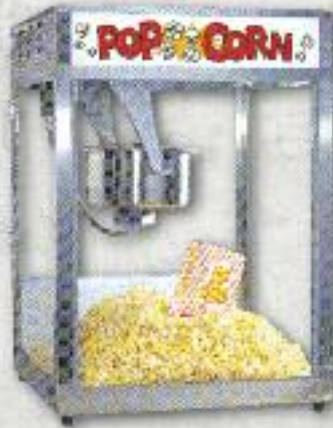

C | Macho Pop 16 oz

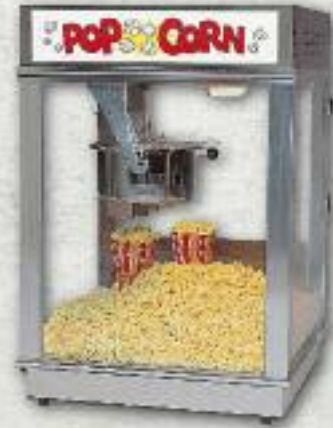

D | Econo-Pop 16 oz

C | Macho Pop 16 oz (Gold Medal)

with illuminated sign, heated bottom plate and filter system
Capacity: approx. 170 L / Hr.
230V; 21 A; 1,920 W
Dimensions: D: 66 W: 66 H: 94 cm
article no. 7B0015

D | Econo-Pop 16 oz (Gold Medal)

with stainless steel roof, heat lamp and heated bottom plate
Capacity: approx. 170 L / Hr.
230V; 24 A; 2,300 W
Dimensions: D: 71 W: 71 H: 102 cm
article no. 7B0014

E | Merchant 16 oz (Cretors)

TÜV/GS tested, with hot air system, stainless steel kettle, 2-stage grease and active carbon filter, equipped for oil pump, with illuminated sign
Capacity: approx. 170 L / Hr.
230V; 10 A; 2,335 W
Dimensions: D: 58 W: 73 H: 104 cm
article no. 7A0024



E | Merchant 16 oz

Popcorn machines 32 oz



F | Mach 5 32 oz

F | Mach 5 32 oz (Cretors)

Counter model with stainless steel kettle and illuminated sign, equipped for oil pump, hot air system with 2-stage grease and active carbon filter
Capacity: approx. 350 L / Hr.
230 / 380V; 23 A; 6,185 W
Dimensions: D: 71 W: 92 H: 140 cm
article no. 7A0123

Mach 5 60 oz (Cretors)

Counter model with stainless steel kettle and illuminated sign, equipped for oil pump, hot air system with 2-stage grease and active carbon filter
Capacity: approx. 640 L / Hr.
230 / 380V; 23 A; 7,735 W
Dimensions: D: 71 W: 92 H: 140 cm
article no. 7A0131

Base cabinet Mach 5 (Cretors)

for all Mach 5 models, with corn drawer and space for an oil pump
Dimensions: D: 71 W: 92 H: 72 cm
article no. 7A0124



G | Mach5 32 oz Red Top

G | Mach 5 32 oz Red Top (Cretors)

Floor model with lighted retro roof and stainless steel kettle, with circulating hot air conditioner, equipped for oil pump
Capacity: approx. 350 L / Hr.
230 / 380V; 23 A; 6,185 Watt
Dimensions: D: 71 W: 92 H: 196 cm
article no. 7A0156

H | Diplomat 32 oz (Cretors)

with hot air system, stainless steel kettle, 2 stage grease and active carbon filter, equipped for oil pump, with illuminated sign
Capacity: approx. 350 L / Hr.
230 / 380V; 18,5 A; 4,500 W
Dimensions: D: 73 W: 93 H: 123 cm
article no. 7A0030



H | Diplomat 32 oz



I | Pop-O-Gold 32 oz

Base Diplomat 32 oz

& Matinee 32 oz (Cretors)

Steel design, 4 wheels, with corn drawer and space for an oil pump
Dimensions: D: 73 W: 93 H: 89 cm
article no. 7A0031

I | Pop-O-Gold 32 oz (Gold Medal)

with hot air system, 2 heat lamps, 3-stage grease filter system, equipped for oil pump
Capacity: approx. 350 L / Hr.
380 V; 2 x 12 A; 5,760 W
Dimensions: D: 71 W: 91 H: 117 cm
article no. 7B0016

Base cabinet Pop-O-Gold 32 oz (Gold Medal)

Stainless steel, flexible storage space
Dimensions: D: 71 W: 91 H: 89 cm
article no. 7B0036

Popcorn machines 32 – 60 oz

A | Grand Pop-O-Gold Deep Well 32 oz (Gold Medal)
 with steel kettle, circulating air system, 2 heat lamps, 3-stage grease filter system, incl. circulating air filter, equipped for oil pump,
 Capacity: approx. 350 L / Hr. for stocking of approx. 190 / 260 L Popcorn
 380 V; 2 x 12 A; 5,760 W
 Dimensions: D: 76 W: 122 H: 198 cm
article no. 7B0017
 Dimensions: D: 76 W: 152 H: 198 cm
article no. 7B0068



A | Grand Pop-O-Gold Deep Well 32 oz

B | Cornado Production head 48 oz (Gold Medal)
 Twist-off lid system, right or left operation
 Capacity: approx. 510 L / Hr.
 380 V; 2 x 13.5 A; 6,350 W
 Dimensions: D: 63 W: 63 H: 117 cm
article no. 7B0019 / 7B0047



B | Cornado Production head 48 oz



C | Giant production head 60 oz

C | Giant production head 60 oz (Cretors)
 Stainless steel kettle, left or right operation, equipped for oil pump
 Capacity: approx. 640 L / Hr.
 230 / 380 V; 21.3 A; 5,900 W
 Dimensions: D: 44 W: 59 H: 83 cm
article no. 7A0039 / 7A0040

D | Production unit Twin Pro-Plant 48 oz (Gold Medal)
 equipped with 2 Cornado production heads 48 oz, incl. production table with Popcorn chute
 Capacity: approx. 1,020 L / Hr.
 380 V; 2 x 13.5 A; 2 x 6,350 W
 Dimensions: D: 93 W: 201 H: 173 cm
article no. 7B0021



D | Production unit Twin Pro-Plant 48 oz

Popcorn machines 60 oz**E | Production unit Giant 60 oz****E | Production unit Giant 60 oz (Cretors)**

equipped with Giant production head 60 oz, table, Popcorn chute and waste drawer

Capacity: approx. 640 L / Hr.

230 / 380V; 21.3 A; 5,900 W

Dimensions: D: 85 W: 135 H: 160 cm

article no. **7A0112**

F | Production unit Twin-Giant 60 oz (Cretors)

equipped with 2 Giant production heads 60 oz, table, Popcorn chute, waste drawer

Capacity: approx. 1,280 L / Hr.

230 / 380V; 1 x 21.5 A; 1 x 23.5 A;

1 x 5,900 W; 1 x 6,100 W

Dimensions: D: 85 W: 211 H: 160 cm

article no. **7A0044**

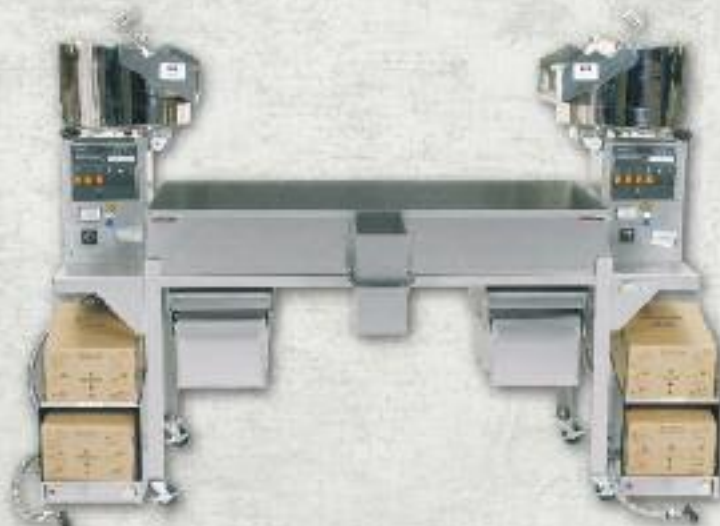
**F | Production unit Twin-Giant 60 oz****G | Twin Enclosed President 60 oz (Cretors)**

equipped with 2 Giant production heads 60 oz, hot air system, 2-stage grease and active carbon filter, equipped for oil pump, illuminated sign

Capacity: approx. 1,280 L / Hr.

230 / 380V; 1 x 23.5 A; 1 x 21.5 A;

1 x 7,800 W; 1 x 6,050 W

Dimensions: D: 71 W: 183 H: 193 cm

article no. **7A0036**

**G | Twin Enclosed President 60 oz**

Popcorn machines Hot Air

**A | Hot Air Popper Model FT40
Continuous (Cretors)**

with digital temperature control for easy setting

Filling capacity per hour: 18 kg corn

Output: approx. 310 L / Hr.

230 / 380 Volt, 10.000 W

Dimensions: D: 81 W: 160 H: 163 cm

article no. 7A0139



A | Hot Air Popper Model FT40

**B | Hot Air Popper Model FT80
Continuous (Cretors)**

with digital temperature control for easy setting and sifter to remove unpopped kernels.

Filling capacity per hour: 36 kg corn

Output: approx. 620 L / Hr.

230 / 380 V; 12,000 W

Dimensions:: D: 112 W: 180 H: 152 cm

article no. 7A0116



B | Hot Air Popper Model FT80

**C | Coating System FT80
Continuous (Cretors)**

for FT80 Popper (not included)

with dry salt applicator (salt)

and liquid-spray system (oil + flavor).

It will spray and coat popcorn to the desired taste and consistency.

230V; 50 / 60 Hz; 10 A

Dimensions: D:120 W:150 H:165 cm

article no. 7A0119



C | Coating System FT80

Popcorn machines Hot Air



D | Production unit POPPI and Double Feature 12 oz

D | Production unit POPPI and Double Feature 12 oz (Cretors)
with Cooling Bin
230V / 380V; 4,990 W
Dimensions: D: 85 W: 211 H: 160 cm
article no. 7A0162

E | Hot Air Popper POPPI (Cretors)
small footprint and minimal clean up
Capacity: 240oz / 6.8 kg / Hr.
Dimensions: D: 42.5 W: 47.5 H: 86 cm
230 V; 3,250 W
article no. 7A0144

F | Double Feature 12 oz Dual (Cretors)
Caramelizer and Popcorn machine
with free standing base
Capacity popcorn: approx. 130 L / Hr.
Capacity caramelized popcorn:
5.4 kg / Hr.
230V; 7.2 A; 1,740 W
Dimensions: D: 48 W: 43 H: 85 cm
article no. 7A0158



E | Hot Air Popper POPPI



F | Double Feature 12 oz Dual

Caramelizers

A | Caramelizer CMD 25 / 16 oz (Cretors)
right hand operation
Capacity: 2.27 kg per batch
respectively 11.33 kg per hour
230V/380V; 3,000 W
Dimensions: D:51 W:41 H:71 cm
article no. 7A0046



A | Caramelizer CMD 25 / 16 oz

B | Caramelizer CMD 50 / 32 oz (Cretors)
right hand operation
Capacity: 4.5 kg per batch
respectively 22.6 kg per hour
230V / 380V, 3,500 W
Dimensions: D:50 W:59 H:78 cm
article no. 7A0138



B | Caramelizer CMD 50 / 32 oz

C | Production unit Giant 60 oz and Caramelizer CMD 50 (Cretors)
with Cooling Bin
230V / 380V; 9,990 W
Dimensions: D: 85 W: 182 H: 160 cm
article no. 7A0163



C | Production unit Giant 60 oz and Caramelizer CMD 50

Popcorn coaters and caramelizers



D | Caramelizer CMD 50 / 32 oz

D | Caramelizer CMD 50 / 32 oz
with Cooling bin with fan
and bag filler
Dimensions D: 85 W: 211 H: 160 cm
article no. **7A0164**

E | Coater Mixer Tumbler (Cretors)
for 5 gallon (approx. 19 liter)
of popped corn,
for powder or liquid coating,
without heat
230V, 200 W
Dimensions: D: 63.5 W: 66 H: 76 cm
article no. **7A0117**



E | Coater Mixer Tumbler



F | Cheese Warmer

F | Cheese Warmer (Cretors)
with adjustable thermostat
230V, 550 W
Dimensions: D: 31 W: 31 H: 25 cm
article no. **7A0157**

G | Caramelizer 64 oz (Cretors)
Right operation;
with cooling table and rack
Capacity: approx. 9 kg per filling /
approx. 45 kg / Hr.
380V; 40 A; 8,700 W
Dimensions: D: 84 W: 254 H: 76 cm
article no. **7A0114**



G | Caramelizer 64 oz

Oil pumps

Bucket pumps

**A | Oil pump for oil in buckets
(Cretors)**

for all Cretors machines
from Merchant up TÜV/GS tested
230 V; 2.5 A; 540 W
Dimensions: D: 33 W: 33 H: 56 cm
article no. 7A0052



A | Oil pump for oil in buckets

**B | Oil pump SC for oil in buckets
(Cretors)**

for T-3000 Plus and Profiteer;
automatic measuring, TÜV/GS tested
230 V; 2.5 A; 540 W
Dimensions: D: 33 W: 33 H: 56 cm
article no. 7A0053



B | Oil pump SC for oil in buckets

**Oil pump for oil in buckets
(Gold Medal)**

230 V; 2.4 A; 520 W
Dimensions: D: 36 W: 32 H: 56 cm
1 Timer setting
article no. 7B0023
2 Timer settings
article no. 7B0056

Bag in the Box

**C | Oil pump Bag in the Box
(Cretors)**

for Popcorn oil in cartons,
with heated tubes
230 V; 1.8 A; 350 W
Dimensions: D: 47 W: 38 H: 61 cm
article no. 7A0054



C | Oil pump Bag in the Box

**D | Oil pump Bag in the Box
(Gold Medal)**

for Popcorn oil in cartons
230 V; 1.1 A; 230 W
Dimensions: D: 38 W: 33 H: 65 cm
article no. 7B0024



D | Oil pump Bag in the Box

Heating Blade

**E | Heating blade Excalibur
(Gold Medal)**

for melting Popcorn oil in buckets
230 V; 1.8 A; 400 W
article no. 7B0030A



E | Heating blade Excalibur

Butter dispenser

F | Butter dispenser
for melting and serving butter
230 V; 2.5 A; 535 W
article no. 7D0002



F | Butter dispenser

Special butter for Popcorn

40 x 250 g / carton
article no. 1120036



G | Backroom warmer Bag in the Box



H | Backroom warmer Bag in the Box

Warmers

G | Backroom warmer Bag in the Box (Gold Medal)
made of stainless steel, for preheating of 2 Bag in the Box cartons
220 V; 0.9 A; 200 W
Dimensions: D: 42 W: 33 H: 58 cm
article no. 7B0029

H | Backroom warmer Bag in the Box (Cretors)
made of stainless steel, for preheating of 4 Bag in the Box cartons
230 V; 2.8 A; 580 W
Dimensions: D: 44 W: 41 H: 126 cm
article no. 7A0058



I | Astro showcase warmer



J | Astro showcase warmer

I | Astro showcase warmer (Gold Medal)
for pre-bagged Popcorn, with illuminated sign on the sliding doors side, 2 adjustable shelf bottoms;
Front side: sliding doors
Back side: winged doors
230 V; 8.5 A; 1,830 W
Dimensions: D: 75 W: 89 H: 112 cm
article no. 7B0025

J | Astro showcase warmer (Gold Medal)
for pre-bagged Popcorn, with illuminated sign, with 2 adjustable shelf bottoms;
Back side: winged doors
230 V; 8.3 A; 1,800 W
Dimensions: D: 71 W: 71 H: 112 cm
article no. 7B0059



K | Astro showcase warmer



L | Showcase warmer Citation

K | Astro showcase warmer (Gold Medal)
for pre-bagged Popcorn, with illuminated sign, 2 adjustable shelf bottoms;
Back side: winged doors
230 V; 8.5 A; 1,830 W
Dimensions: D: 75 W: 89 H: 112 cm
article no. 7B0058

L | Showcase warmer Citation (Gold Medal)
for bulk Popcorn with circulating hot air system and plexiglas winged doors
230 V; 1,100 W
Dimensions: D: 51 W: 71 H: 97 cm
article no. 7B0055

Warmers

A | Diplomat showcase warmer (Cretors)
 for pre-bagged Popcorn, circulating hot air system, with illuminated sign on the sliding doors side,
 2 adjustable shelves;
 Front side: sliding doors;
 230 V; 9 A; 2,000 W
 Dimensions: D: 72 W: 92 H: 114 cm
article no. 7A0071



B | Diplomat showcase warmer (Cretors)
 Steel design, with illuminated sign on the sliding doors side, circulating hot air system, for pre-bagged Popcorn, with internal side mirrors and 2 adjustable shelf bottoms;
 Front side: plexiglas sliding doors;
 Back side: stainless steel folding doors
 230 V; 9 A; 2,000 W
 Dimensions: D: 72 W: 92 H: 114 cm
article no. 7A0072

A | Diplomat showcase warmer

B | Diplomat showcase warmer

C | Popcorn station special
 Storage and shelf warmer for self-service, filling from the back side
 230 V; 2,000 W; 16 A
 Dimensions: D: 99 W: 91 H: 210 cm
article no. 7A0065



D | Counter showcase warmer, mirrored, 51 cm (Cretors)
 for the front counter, made from CNS stainless steel and safety glass, mirrored inner cabinet, 4 low-voltage lamps, retractable hatch opening
 230 V; 2.8 A; 555 W
 Dimensions: D: 76 W: 51 H: 68.5 cm
article no. 7A0062

C | Popcorn station special

D | Counter showcase warmer, 51 cm

E | Counter showcase warmer, 92 cm
 for the front counter, made from CNS stainless steel and safety glass, mirrored and illuminated inner cabinet, retractable hatch opening
 230 V; 2.8 A; 555 W
 Dimensions: D: 76 W: 92 H: 68.5 cm
article no. 7A0060 / 7B0026



F | Counter showcase warmer, 122.5 cm
 for the front counter, made from CNS stainless steel and safety glass, mirrored and illuminated inner cabinet, retractable hatch opening
 230 V; 2.8 A; 555 W
 Dimensions: D: 76 W: 122,5 H: 68,5 cm
article no. 7A0063 / 7B0027

E | Counter showcase warmer, 92 cm

F | Counter showcase warmer, 122.5 cm

Warmers

G | Counter Showcase Warmer, 3 doors

for the front counter, made from CNS stainless steel and safety glass, mirrored and illuminated inner cabinet, made of stainless CNS steel, with 4 low-voltage lamps, 3 retractable hatch openings
230 V; 3,4 A; 555 W
Dimensions: D: 76 W: 122,5 H: 68,5cm
article no. 7A0141



G | Counter Showcase Warmer, 122,5 cm

H | Counter showcase warmer, rear counter, 92 cm (Cretors)

for the Popcorn stock in the rear buffet, made from CNS stainless steel, with 4 low-voltage lamps, retractable hatch opening
230 V; 2,8 A; 555 W
Dimensions: D: 76 W: 92 H: 68,5 cm
article no. 7A0064



H | Counter showcase warmer



I | Counter showcase warmer

I | Counter showcase warmer (PCO)

for the front counter, made from CNS stainless steel and safety glass, mirrored and illuminated inner cabinet, retractable hatch opening. With a 1/3 - 2/3 subdivision, the heating counter can be supplemented with a bag holder.
230 V; 6,9 A; 1,500 W
Dimensions: D: 75 W: 122.3 H: 96.8 cm
article no. 7H0001

J | Mounting shelf

for heating Nachos and Dips
for Counter showcase warmer
7A0060 and 7A0063
article no. A11038 / A11039

K | Partition wall

for Cretors counter showcase warmer
article no. S7925
for Gold Medal counter showcase warmer 7B0026 and 7B0027
article no. H098-00



J | Mounting shelf



K | Partition wall

Warmers

A | Cabinet warmer PCO 60 cm
 floor model with hot air conditioning system, inside lights with LEDs, wing door and with 5 adjustable shelves
 Warming capacity: approx. 100 litre popcorn
 230V, 1.300 W
 Dimensions: D: 60 W: 60 H: 200 cm
article no. 7H0007



A | Cabinet warmer PCO 60 cm

B | Cabinet warmer PCO 90 cm
 floor model with hot air conditioning system, inside lights with LEDs, double wing doors and with 5 adjustable shelves
 Warming capacity: approx. 200 litre popcorn
 230V, 1.300 W
 Dimensions: D: 60 W: 90 H: 200 cm
article no. 7H0008

Cabinet warmer PCO 90 cm with back door
 floor model with hot air conditioning system, inside lights with LEDs, double wing doors on front side and with 5 adjustable shelves
 Filling from the back side possible
 Warming capacity: approx. 200 litre popcorn
 230V, 1.300 W
 Dimensions: D: 60 W: 90 H: 200 cm
article no. 7H0009



B | Cabinet warmer PCO 90 cm

C | Open warmer
 for Popcorn and Nachos on 3 levels with spitting protection, heat retention through infrared warmers and heating mats, front of the warmer is open; back side with sliding doors, 2 light boxes with Popcorn image: 95 x 45 cm, interior lighting with fluorescent tubes, CE certified.
The width (from 200 cm) can be individually adjusted!
 Warmer dimensions: D: 70 H: 210 cm
 230 / 380 V; 3,680 W
 High voltage supply required
article no. 7H0005



C | Open warmer

Accessories

D | Measuring cups for corn and sugar
available for all kettle sizes

E | Popcorn scoops
available right- or left-handed,
perforated and unperforated

F | Measuring spoons for salt
available for all kettle sizes

G | PopClean kettle cleaner
1 L bottle
article no. 4100064
12 x 1 L / carton
article no. 4100063



D | Measuring cups for corn and sugar



E | Popcorn scoops



F | Measuring spoons for salt



G | PopClean kettle cleaner



Advertising material

We are happy to make available our Popcorn posters for free in sizes from A3 to A0 and our promotional DVDs with images.

Kernel Season's

Provide your customers Popcorn with a larger variety of flavours. Spice up Popcorn with Kernel Season's – right at the counter or to take away.

Popcorn seasonings

A | Flavours

BBQ

1 x 906 g article no. 1130101

Butter

48 x 25 g article no. 1130079

6 x 80 g article no. 1130067

1 x 906 g article no. 1130098

Nacho Cheddar

48 x 25 g article no. 1130078

6 x 80 g article no. 1130066

1 x 906 g article no. 1130097

Parmesan & Garlic

6 x 80 g article no. 1130062

1 x 906 g article no. 1130093

Ranch

1 x 906 g article no. 1130100

Sour Cream & Onion

48 x 25 g article no. 1130080

6 x 73 g article no. 1130068

1 x 906 g article no. 1130055

Chocolate & Marshmallow

6 x 85 g article no. 1130069

1 x 906 g article no. 1130099

White Cheddar

48 x 25 g article no. 1130076

6 x 80 g article no. 1130064

1 x 906 g article no. 1130095

Caramel

48 x 25 g article no. 1130085

1 x 906 g article no. 1130104



A | Kernel Season's Popcorn seasonings



B | Floor display



C | Counter display



D | Mini-Shaker shelf

Sales displays

B | Floor display

article no. 7S0028

C | Counter display

article no. 7S0032

D | Mini-Shaker shelf

article no. 7S0041

With our spicy corn chips you offer your customers a snack that is always welcome, with a varied selection of delicious Dips.

Hot products,
hot presentation,
hot sales!



Hombre Nachos & Dips – the best solution for everyone

Hombre Nachos

Our nachos are available in 125 g bags. Here we present our new design, a great eye-catcher at every counter and on every shelf. Naturally we also supply bulk nachos in larger bags (up to 800 g) for sales out of the warmer.



Hombre Dips

There's something for everyone within our selection of Dips: a range of mild, spicy and hot Salsa-Dips, various Cheese-Dips, Guacamole and Sour-Cream.

And the packaging is as diverse as the products they contain, stretching from portion packs to jars and dispenser pouches. All in the appropriate size. The hot and spicy Hombre Jalapeño Peppers also come in a range of different-sized packs.



Nacho trays

For the open sale of Nachos we have every type of tray you could wish for. Plastic trays are available in a number of sizes, shapes and colours. We also have cardboard trays with printed designs – a real eye-catcher.



Equipment

Nachos sold in trays - and the cheese dip, too - should be eaten warm. Naturally we can supply you with the necessary equipment for every situation and for every POS set-up – from warmers for individual portions to high-tech pumps. And of course we are happy to advise you on the best equipment.



Nachos & Dips combos

Eating Nachos and Dips as a combo is the best way to enjoy them, so we have a range of solutions for you. No party is complete without a Nacho Party Sonne, which holds Nachos and Dips for a number of people and to suit a range of tastes. Individualists may want to eat their Nachos from a practical IML cup with a Dip attached to the lid in easy reach. The latest gimmick is our Nachos and Dip-Box. A 360° perforation and a lateral flap: with a few simple movements the box turns into a real Nacho tray. 100g Hombre Nachos plus Dip – Salsa- or Cheese-Dip or Sour-Cream.



How it works:



1. Remove the film and open the box along the perforation. The top can be removed completely.
2. The box contains a bag of crispy Nachos and your choice of Dip.
3. The flap located on the side of the box holds the Dip. Open the bag of Nachos and tip them into the box.
4. Relax and enjoy!

Nachos

A | Hombre Nachos Barbecue
3 x 800 g bags / carton
article no. 2110001

B | Hombre Nachos Classic
3 x 800 g bags / carton
article no. 2110011

C | Hombre Nachos Paprika-Chili
3 x 750 g bags / carton
article no. 2110042

D | Hombre Nachos Barbecue
20 x 125 g bags / carton
article no. 2110003

E | Hombre Nachos Classic
20 x 125 g bags / carton
article no. 2110021

F | Hombre Nachos Paprika-Chili
20 x 125 g bags / carton
article no. 2110043



A | Hombre Nachos Barbecue

C | Hombre Nachos Paprika-Chili

B | Hombre Nachos Classic

Nachos & Dips

G | Hombre Nachos & Dips
24 cups (75 g Nachos +
90 g **Salsa-Dip**) / carton
article no. 8510011
168 cups (75 g Nachos +
90 g **Salsa-Dip**) / display
article no. 8510013

24 cups (75 g Nachos +
90 g **Sour-Cream**) / carton
article no. 8510023
168 cups (75 g Nachos +
90 g **Sour-Cream**) / display
article no. 8510025

24 cups (75 g Nachos +
90 g **Cheese-Dip**) / carton
article no. 8510015
168 cups (75 g Nachos +
90 g **Cheese-Dip**) / display
article no. 8510017

24 cups (75 g Nachos +
90 g **Guacamole**) / carton
article no. 8510019
168 cups (75 g Nachos +
90 g **Guacamole**) / display
article no. 8510021

24 cups assorted / carton
article no. 8510026
168 cups assorted / display
article no. 8510027



D | Hombre Nachos Barbecue

E | Hombre Nachos Classic

F | Hombre Nachos Paprika-Chili



G | Hombre Nachos & Dips



H | Hombre Nacho-Party-Sonne



I | Hombre Nachos and Dip Box

H | Hombre Nacho-Party-Sonne
2 x 150 g Nachos + 3 x 90 g Dips
(Salsa-Dip, Cheese-Dip, Sour-Cream)
10 pcs / carton
article no. 8510064

I | Hombre Nachos and Dip Box
100 g Hombre Nachos Paprika-Chili +
90 g Hombre Salsa-Dip
12 boxes / carton
article no. 8510045
96 boxes / display
article no. 8510047



J | Hombre Salsa-Dip, spicy
K | Hombre Salsa-Dip, mild

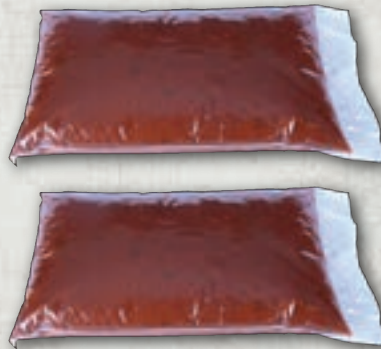

L | Hombre Salsa-Dip, spicy
M | Hombre Salsa-Dip, mild

100 g Hombre Nachos Paprika-Chili +
90 g Hombre Cheese-Dip
12 boxes / carton
article no. 8510049
96 boxes / display
article no. 8510051

100 g Hombre Nachos Paprika-Chili +
90 g Hombre Sour-Cream
12 boxes / carton
article no. 8510053
96 boxes / display
article no. 8510055

Dips

J | Hombre Salsa-Dip, spicy
4 x 2.5 kg jars / carton
article no. 2120017

K | Hombre Salsa-Dip, mild
4 x 2.5 kg jars / carton
article no. 2120002

L | Hombre Salsa-Dip, spicy
4 x 2 kg pouches / carton
article no. 2120026

M | Hombre Salsa-Dip, mild
3 x 3 kg pouches / carton
article no. 2120022

N | Hombre Salsa-Dip, hot
6 x 2.05 kg dispenser jug / carton
article no. 2120007

O | Hombre Salsa-Dip, hot
3 x 2.65 kg cans / carton
article no. 2120006

P | Hombre Sour-Cream
6 x 2.05 kg dispenser jug / carton
article no. 2120035

Q | Hombre Sour-Cream
4 x 2 kg pouches / carton
article no. 2120033



N | Hombre Salsa-Dip, hot



O | Hombre Salsa-Dip, hot



P | Hombre Sour-Cream



Q | Hombre Sour-Cream

A | Hombre Barbecue-Dip
 4 x 4 kg Folienbeutel / Karton
 zu Artikelnr. 7A0154
Artikelnr. 2120044



A | Hombre Barbecue-Dip



B | Hombre Sweet Chili-Dip

B | Hombre Sweet-Chili-Dip
 4 x 4 kg Folienbeutel / Karton
 zu Artikelnr. 7A0154
Artikelnr. 2120045

C | Hombre Basilikum-Dip
 4 x 4 kg Folienbeutel / Karton
 zu Artikelnr. 7A0154
Artikelnr. 2120046



C | Hombre Basilikum-Dip



D | Hombre Sour-Cream-Dip

D | Hombre Sour-Cream
 4 x 4 kg pouches / carton
 for article no. 7A0154
article no. 2120042

E | Hombre Salsa-Dip spicy
 4 x 4 kg pouches / carton
 for article no. 7A0154
article no. 2120041



E | Hombre Salsa-Dip, spicy

F | Hombre Cheese-Dip
 48 x 90 g portion cups / carton
article no. 2120024



F | Hombre Cheese-Dip

G | Hombre Salsa-Dip, spicy
 48 x 90 g portion cups / carton
article no. 2120023



G | Hombre Salsa-Dip, spicy

H | Hombre Salsa-Dip, hot
 45 x 90 g portion cups / carton
article no. 2120005



H | Hombre Salsa-Dip, hot

I | Hombre Guacamole
 48 x 90 g portion cups / carton
article no. 2120029



I | Hombre Guacamole

J | Hombre Sour-Cream
 48 x 90 g portion cups / carton
article no. 2120032



J | Hombre Sour-Cream



K | Hot-Top Cheese-Dip
with adapter
4 x 4 kg pouches / carton
article no. 2120009

L | Display carton
4 x 6 portion cups / carton
(Salsa-Dip spicy, Guacamole,
Cheese-Dip, Sour-Cream)
article no. 2120034

K | Hot-Top Käse-Dip



L | Hombre Dips im Display-Karton



M | Hombre Jalapeño Peppers



N | Hombre Jalapeño Peppers

Jalapeño Peppers

M | Hombre Jalapeño Peppers
6 x 2.9 kg cans / carton
article no. 2130006

N | Hombre Jalapeño Peppers
6 x 2.83 kg jars / carton
article no. 2130007

Hombre Jalapeño Peppers
12 x 453 g jars / carton
article no. 2130013

O | Hombre Jalapeño Peppers
Jalapeño portion pack
300 x 19.8 g / carton
article no. 2130012

P | Hombre Jalapeño Peppers Box
Jalapeño portion pack
48 x 19.8 g / box
article no. 2130014
2 x 48 x 19.8 g / box
article no. 2130015



O | Hombre Jalapeño Peppers



P | Hombre Jalapeño Peppers Box



Originators of Concession Nachos.

A | Ricos Cheese-Dip, 4-pack,
suitable for microwaves
12 x 4 x 99 g portion cups / carton
article no. 2120015

B | Ricos Cheese-Dip
48 x 99 g portion cups / carton
article no. 2120013

C | Ricos Cheese-Dip
6 x 3.03 kg cans / carton
article no. 2120011

D | Ricos Cheese-Dip
with adapter
4 x 3.97 kg pouches / carton
article no. 2120014



A | Ricos Cheese-Dip, 4-pack



B | Ricos Cheese-Dip

**PCO: your exclusive partner
for Ricos products**



C | Ricos Cheese-Dip



D | Ricos Cheese-Dip

Nacho trays



E | Nacho trays, clear, small, for 1 open Dip
500 pcs / carton
article no. 2210004

Nacho trays, black, small, for 1 open Dip
500 pcs / carton
article no. 2210029



F | Nacho trays, clear, large, for 1 Dip
500 pcs / carton
article no. 2210005

Nacho trays, black, large, for 1 Dip
500 pcs / carton
article no. 2210030

E | Nacho trays, small, for 1 open Dip

F | Nacho trays, large, for 1 Dip



G | Nacho trays, clear, large, for 2 open Dips
500 pcs / carton
article no. 2210006

Nacho trays, black, large, for 2 open Dips
500 pcs / carton
article no. 2210011



H | Nacho trays, clear, large, for 2 Dips
300 pcs / carton
article no. 2210003

Nacho trays, black, large, for 2 Dips
300 pcs / carton
article no. 2210028

G | Nacho trays, large, for 2 open Dips

H | Nacho trays, large, for 2 Dips

I | Nacho trays, black, large, for 3 Dips
210 pcs / carton
article no. 2210031



I | Nacho trays, large, for 3 Dips

NACHOS & DIPS

A | Nacho trays, black, small, for 1 open Dip
1,000 pcs / carton
article no. 2210007



A | Nacho trays, small, for 1 open Dip

B | Nacho trays, black, large, for 1 open Dip
600 pcs / carton
article no. 2210008



B | Nacho trays, large, for 1 open Dip

C | Nacho trays, red, small, for 1 open Dip
500 pcs / carton
article no. 2210012



C | Nacho trays, small, for 1 open Dip

D | Nacho trays, red, large, for 1 open Dip
500 pcs / carton
article no. 2210013



D | Nacho trays, large, for 1 open Dip

E | Dip trays, orange
1,000 pcs / carton
article no. 2210016



E | Dip trays, orange

F | Dip trays, clear
1,000 pcs / carton
article no. 2210017



F | Dip trays and lid, clear

Lid for Dip trays, clear
1,000 pcs / carton
article no. 2210018

G | Nacho trays, carton for 1 Dip
250 pcs / carton
article no. 2210024



G | Nacho trays for 1 Dip

H | Nacho trays, carton for 2 Dips
250 pcs / carton
article no. 2210025



H | Nacho trays for 2 Dips

Private Label

I | Private Label

You want Nacho products with your own brand? We will prepare an individual quotation for you.

Open warmer

J | Open warmer

for Popcorn and Nachos on 3 levels with spitting protection, heat retention through infrared heaters and heating mats, front of the warmer is open; back side with sliding doors, 2 light boxes, interior lighting with fluorescent tubes, CE certified

230/380 V; 3,680 W

Dimensions: D: 70 H: 210 cm

Width from 200 cm

High voltage supply required.
article no. 7H0005

K | Mounting Dip shelf

for open warmer 7H0005,
10 compartments each of 4 Dips
Dimensions: D: 17.9 W: 90 cm
article no. 7H0013

13 compartments each of 4 Dips
Dimensions: D: 17.9 W: 116.5 cm
article no. 7H0014



I | Private Label (examples)



K | Mounting Dip shelf



J | Open warmer

Nacho warmers

A | Nacho tray warmer, small (Gold Medal)

with 3 adjustable shelves for warming pre-portioned Nacho trays and Cheese-Dip in portion cups
230 V; 420 W
Dimensions: D: 39 W: 32 H: 58 cm
article no. 7B0039



A | Nacho tray warmer, small

B | Nacho tray warmer, medium (Gold Medal)

with 3 adjustable shelves for warming pre-portioned Nacho trays and Cheese-Dip in portion cups
230 V; 460 W
Dimensions: D: 47 W: 47 H: 58 cm
article no. 7B0040



B | Nacho tray warmer, medium

C | Nacho tray warmer, medium (Cretors)

with circulating hot air, for warming pre-portioned Nacho trays and Cheese-Dip in portion cups, with Nacho light display, available for the front or rear counter
230 V; 2.5 A; 560 W
Dimensions: D: 49 W: 47 H: 68 cm
article no. 7A0075 / 7A0076



C | Nacho tray warmer, medium

D | Nacho tray warmer, large (Cretors)

for front merchandising, with circulating hot air, new lighted nachos-sign, ideal for warming and storing Nachos, ready-to-serve trays and Cheese-Dip portion packs
230 V, 2.5 A, 560 W
Dimensions: D: 45 W: 45 H: 90 cm
article no. 7A0145



D | Nacho tray warmer, large

E | Nacho warmer (Gold Medal)

with heated bottom plate for 3.0 kg bulk Nachos
230 V; 90 W
Dimensions: D: 39 W: 30 H: 60 cm
article no. 7B0037



E | Nacho warmer

F | Nacho warmer (Gold Medal)

with heated bottom plate for 4.5 kg bulk Nachos
230 V; 90 W
Dimensions: D: 32 W: 39 H: 60 cm
article no. 7B0038



F | Nacho warmer



G | Nacho circulation air warmer



H | Cheese dispenser

G | Nacho circulation air warmer (Cretors)

for front and rear counter, holds 6 kg bulk Nachos evenly warm, with Nacho light display
230 V; 2.5 A; 560 W
Dimensions: D: 49 W: 47 H: 68 cm
article no. 7A0073 / 7A0074

Dip dispensers

H | Cheese dispenser (Cretors)

with Nacho light display for the front counter, made from scratch proof stainless steel; warming cabinet and electric pump with three-stage portioning possibility, holds two Cheese-Dip pouches.
230 V; 2.0 A; 400 W
Dimensions:
D: 51 (F) D: 41 (R) W: 31 H: 51 cm
article no. 7A0079 / 7A0080



I | Cheese dispenser



J | Cheese dispenser

I | Cheese dispenser (Hot-Top)

for Cheese-Dip in pouches; Cheese is heated in the pouch, a second pouch pushes down from above and is simultaneously preheated
230 V; 220 W
Dimensions: D: 43 W: 23 H: 56 cm
article no. 7G0001

J | Cheese dispenser (Gold Medal)

with 3 control buttons for Cheese in pouches, holds two pouches, temperature setting: from min. 63°C to max. 69°C
230 V; 225 W
Dimensions: D: 40 W: 25 H: 65 cm
article no. 7B0069



K | Cheese warmer pump (Server)

for the front or rear counter, with Nacho sign, outlet and switch on one side
230 V; 2.5 A; 535 W
Dimensions: D: 39 W: 22 H: 40 cm
article no. 7D0004

L | Cheese Dispenser (Cretors)

electrical dispenser made of stainless, scratch proof steel, with heating compartment, with electric heat pump, 3-stage heating control, holds one sealed plastic pouche with 4 kg
230 V; 2.0 A; 380 W
Dimensions: D: 41 W: 16 H: 46 cm
article no. 7A0155



K | Cheese warmer pump



L | Dip dispenser

A | Salsa pump (Server)

made of sturdy plastic, for attachment on Dip containers made of stainless steel 7D0006
article no. 7D0007

Dip container (Server)

made of stainless steel, for Cheese warmer pump 7D0003 and Salsa pump 7D0007 (not supplied with Cheese warmer pump and / or Salsa pump)
article no. 7D0006



A | Salsa pump and Dip container

B | Salsa pump 10 liters (Gastroback)

with stainless steel cover
 Capacity: 10 liters
article no. 7S0213

Dip container 10 liters (Gastroback)

made of stainless steel for Salsa pump 7S0213
 Capacity: 10 liters
article no. 7S0214



B | Salsa pump and Dip container

Jalapeño coolers

C | Jalapeño cooler (Server)

with thermo-electric cooling, made of brushed stainless steel, with plastic cover. The device cools the Jalapeños in an aluminum container to below 5°C.
 230V; 60 W; 50 Hz
 Dimensions cooler:
 D:18.5 W: 18.5 H: 25 cm
 Dimensions aluminum container:
 (capacity: 1.9 Liters)
 T: 12.5 B:12.5 H:12.5 cm
article no. 7D0013



C | Jalapeño cooler

D | Jalapeño cooler (Server)

Cooler made of brushed stainless steel, with plastic cover. For cooling with cool packs (up to 4 hours); the Jalapeños are cooled in a stainless steel container. Stainless steel container and cool packs are not included.
 Dimensions cooler:
 D:24.8 W: 22.4 H: 21.9 cm
article no. 7D0008
 Stainless steel container
article no. D90088
 Cool pack
article no. D94013



D | Jalapeño cooler



E | Nacho Island, large

Nacho Island

E | Nacho Island, large
for the self-service concept, with 4 Nacho warmers, 8 narrow and 2 wide Dip-Dispensers and 8 chillers, bottom part with drawers and lockable cabinets with wing doors to store supplies upper part with roof incl. 2 LCD widescreen monitors and 2 illuminated signs, LEDs on bottom part and roof with multiple color selection and light options as for example blinking lights, bottom part with wheels for a flexible place of action.
230 / 380V, 3x16 A, 8,000 W
Dimensions: W: 300 D: 120 H: 204 cm
article no. 7S0212



F | Napkin dispenser, small



G | Napkin dispenser, large

Accessories



H | Dispenser napkins, small



I | Dispenser napkins, large

F | Napkin dispenser, small
for 300 napkins
Dimensions: D: 34 W: 16 H: 13 cm
article no. 7S0100

G | Napkin dispenser, large
for 300 napkins
Dimensions: D: 34 W: 22 H: 13 cm
article no. 7S0101

H | Dispenser napkins, small
36 x 300 pcs / carton
unfolded dimensions: 25 x 30 cm
matching for article no. 7S0100
article no. 4900006

I | Dispenser napkins, large
24 x 250 pcs / carton
unfolded dimensions: 32 x 33 cm
matching for article no. 7S0101
article no. 4900004



J | Dispenser



K | Dispenser

J | Dispenser
for Hombre Salsa-Dip in the dispenser jug
1 pc.
for article no. 2120007
article no. 2300005

K | Dispenser
for Salsa-Dip in jars
1 pc.
for article no. 2120002, 2120003, 2120017
article no. 2300002

A | Nacho scoop right
1 pc
article no. **A1209**

Nacho scoop left
1 pc
article no. **A1209-L**

B | Jalapeño plastic tongs
1 pc
article no. **2300003**

C | Jalapeño metal tongs
1 pc
article no. **D3774BK**

D | Hombre napkins
4,000 pcs / carton
article no. **4900014**

A | Nacho scoop right and left



Advertising material

E | Hombre Nachos poster roll
3 posters each in A0, A1, A2 and A3
article no. **6120010**



B | Jalapeño plastic tongs

C | Jalapeño metal tongs



D | Hombre napkins

E | Hombre Nachos poster roll

IceKing slushy - a fruity delight

With IceKing slushy we offer all the products you need for your professional slush range: high-quality syrup for making iced slushy, slushy machines and funny flutes with matching straws.



IceKing is more

Colorful slushys, fruity lemonade and light milkshakes – IceKing has everything slushy fans of all ages could ask for.



IceKing slushy

IceKing Slushy now comes in a dozen different fruity colours and flavours. We recommend that you try a mixture of flavours from one of our unique flutes then you can decide whether you prefer a single flavour or a combination, and it looks great too!

IceKing Lemonade

A new way to enjoy chilled lemonade. The flowing lemon flavoured fountain in the IceKing Lemonade Machine is bound to get mouths watering and there's no beating it straight from the tap. The high-quality cups look great and are reusable. Plus the dome-lids are designed to take one of our many funky toppers.



IceKing shake

Shake it, Baby! IceKing Shakes are for people with a sweet tooth. Fruity strawberry shake or creamy chocolate shake – irresistible! and to feel wide awake try IceKing Iced Coffee. But a word of warning. It's addictive!



Interested? Or maybe already convinced? PCO will supply you with all the equipment needed for a successful slush shop. The best ingredients for the best slush. IceKing doesn't just guarantee a taste that's second to none; we also take our ingredients very seriously. Our top-quality syrups have zero preservatives and no harmful colourings, but they're still popular for their bright colours. The syrup comes in hygienic bag in the box packs which provides product longevity, keeps waste to a minimum and is easy to dispose of.

IceKing equipment

It goes without saying that PCO will supply you with the best equipment for each product and counter set-up. Machines with one, two or three containers – 10 or 15 litres – with or without base. You choose. We will happily advise you. On top of that you'll get an instruction DVD to help you with installation and cleaning. Training new staff is child's play with our equipment.



IceKing packaging

The IceKing slush packaging is really eye catching, making it the supreme advertising vehicle. Flutes with multicoloured slush and happy kids' faces – "I want one, too!!!" and it's not just our flutes of all sizes that are a big hit with kids of all ages, our dome-lid cups and toppers are just as popular. All cups and flutes can be taken home and reused, or better still: spoil your customers with a great refill offer.



slushy sirup

A | slushy sirup

Woodruff
10 L / carton
article no. 5610006

Wild Berry
10 L / carton
article no. 5610004

Strawberry
10 L / carton
article no. 5610008

Peach Passion Fruit
10 L / carton
article no. 5610017

Cherry
10 L / carton
article no. 5610007

Cola
10 L / carton
article no. 5610003

Lime
10 L / carton
article no. 5610009

Orange
10 L / carton
article no. 5610012

Pineapple
10 L / carton
article no. 5610020

Green Apple
10 L / Karton
article no. 5610018

Raspberry
10 L / carton
article no. 5610019

Melon
10 L / carton
article no. 5610021

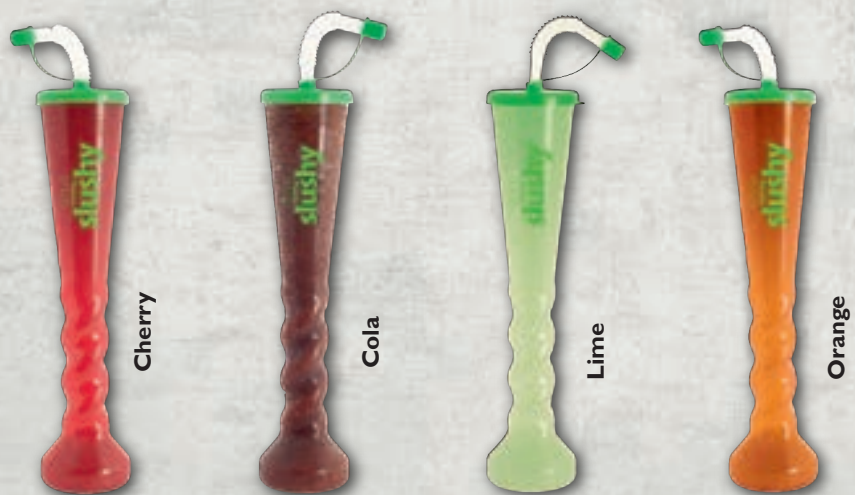

A | slushy sirup

slushy machines

A | IceKing 2 slushy machine, 2 x 10 L containers
 with light display and patented magnetic coupling flange. Advantages: no direct contact between the beverage container and motor, easier cleaning
 230V; 1,100 W
 Dimensions: D: 47 W: 36 H: 69 cm
article no. 7E0006



A | slushy machine, 2 x 10 L



B | slushy machine, 3 x 10 L

B | IceKing 3 slushy machine, 3 x 10 L containers
 machine description as 7E0006,
 230V; 1,300 W
 Dimensions: D: 47 W: 54 H: 69 cm
article no. 7E0007

C | IceKing slushy machine, Giant 2 x 15 L containers
 machine description as 7E0006,
 230V; 1,600W
 Dimensions: D: 46 W: 52.5 H: 82 cm
article no. 7E0010



C | slushy machine, 2 x 15 L

D | Base for slushy machine
 designed in steel, with 4 wheels, 2 of which have brakes, and two additional shelves for syrup, cups and drinking straws
 Dimensions base cabinet:
 D: 54 W: 65 (103 with table) H: 88 cm
article no. 7E0022S



D | Base for slushy machines

Our slushy machines are now also available with an autofill-system – we are happy to advise you.

slushy cups and slushy flutes

E | slushy cups
(without drinking straw and topper),
with lids, also good for toppers
250 pcs / carton
article no. 3170012

drinking straws, flexible, with caps
250 pcs / carton
article no. 3310013

Topper penguin
250 pcs / carton
Artikelnr. 3410001

F | slushy flutes L
with lids and drinking straws
50 pcs / carton
article no. 3170001

**G | slushy flutes L,
with penguin lids
and drinking straw**
33 pcs / carton
article no. 3170014

H | slushy flutes XL
with lids and drinking straws,
50 pcs / carton
article no. 3170002

I | slushy flutes XXL
with lids, drinking straws and handle,
40 pcs / carton
article no. 3170007



E | slushy cups



F | slushy flutes L



G | slushy flutes L,
with penguin lid



H | slushy flutes XL



I | slushy flutes XXL

Accessories

A | Lighted flute dispenser
with changing lights
12V; 15W
Dimensions: D: 46 W: 36 H: 13 cm
article no. 7E0024

B | Illuminated giant flute
with rechargeable battery for approx.
12 hours.
12V / 15W
W: 40 cm; H: 160 cm
article no. 7E0021



A | Illuminated giant flute

B | Lighted flute dispenser



C | Measuring cup 3 L, with lid



D | Measuring cup 5 L, with lid

C | Measuring cup 3 L
1 pc / carton
article no. E0009

Lid for measuring cup 3 L
1 pc / carton
article no. E0010

D | Measuring cup 5 L
1 pc / carton
article no. E0003

Lid for measuring cup 5 L
1 pc / carton
article no. E0004

E | slushy shaker for the basic mix
for 2 litres
1 pc
article no. 5690009



E | slushy shaker for the basic mix



F | Food grade grease

F | Food grade grease
for slushy machines
250 ml can
article no. S530005

G | Special oil
for IceKing slushy sirup
250 ml bottle
article no. 5690007



G | Special oil



H | Pipette

H | Pipette
1 pc
article no. 5690006

I | Adapter for slushy syrups
for automatic dispensing
1 pc
article no. 5690004



I | Adapter for slushy syrups

Advertising material for IceKing slushy and lemonade

With table displays, ceiling dangles, wobblers, posters and illuminated giant flutes, we offer a wide range of attractive advertising material, that in some cases is for free.

You will also receive flavor labels with suction cups for IceKing slushy and lemonade for free with your order.

Brand new and really cool: our beachflags, squeezeballs and parasols!

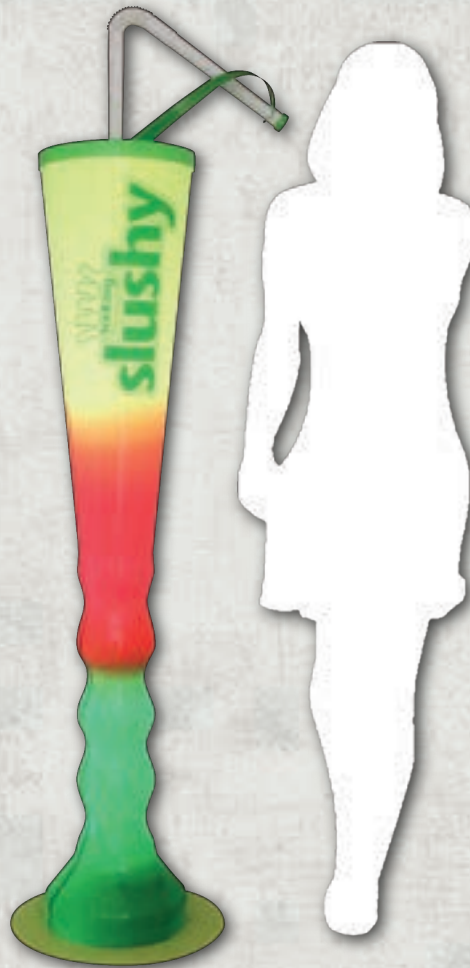

Illuminated giant flutes



Ceiling dangles



Squeeze ball

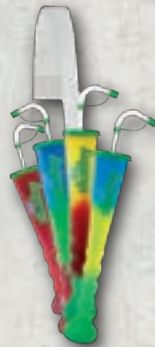

Wobblers



Beach flag



Posters



Table displays

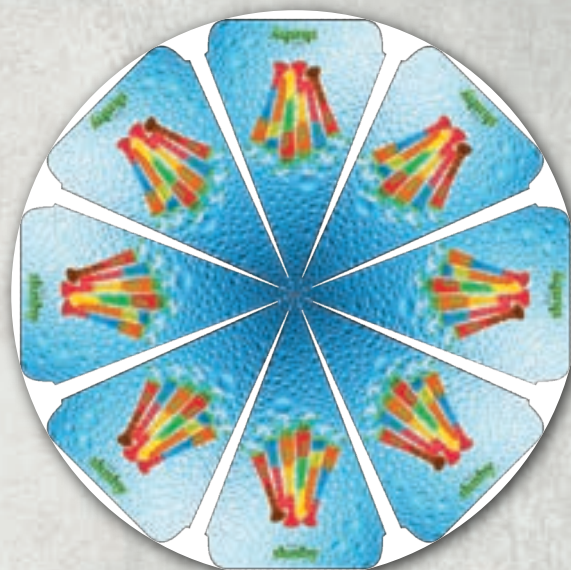

Parasol

Flavor labels for IceKing slushy, with suction cups

IceKing slushy raffle promotion

Our raffle promotion

Upon purchasing 50 XL flutes you will receive a raffle package with 50 tickets, including

- 1 x 1 ticket for a football
- 4 x 1 ticket for a squeeze ball
- 2 x 1 ticket for a refill
- 43 x 1 ticket "Sadly not"

Upon purchasing 40 XXL flutes you will receive a raffle package with 40 tickets, including

- 1 x 1 ticket for a football
- 4 x 1 ticket for a squeeze ball
- 2 x 1 ticket for a refill
- 33 x 1 ticket "Sadly not"

Tickets and prizes are delivered for free upon request when ordering slushy flutes XL and XXL after 15 May. With this free raffle your customers can win a football (main prize), four squeeze balls and two refills for more slushies directly from you.

Here's how it works:

If your customer buys an XL IceKing slushy he receives one of the 50 tickets. Your customer will redeem their ticket with you directly. You throw in the two refills when redeeming the winnings.

If your customer buys an XXL IceKing slushy, he receives one of the 40 tickets. Your customer will redeem their ticket with you directly. You throw in the two refills when redeeming the winnings.

This promotion is valid until 31-12-2016.

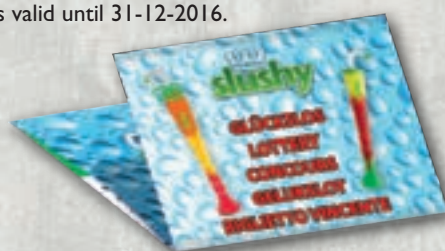

IceKing shake for iced coffee, iced chocolate, strawberry milk

Shake sirup

A | Iced coffee
9 L / carton
article no. 5610013

Iced chocolate
10 L / carton
article no. 5610014

**IceKing slushy sirup
strawberry**
10 L / carton
article no. 5610008

**slushy basic mix
for iced coffee and strawberry**
20 x 500 g
article no. 5610015



A | IceKing slushy sirup and basic mix

Flutes and cups

B | IceKing shake cup
with lids, also good for toppers
250 pcs / carton
article no. 3170012

Drinking straws, flexible, with caps
250 pcs / carton
article no. 3310013

C | slushy futes de luxe
with lid and drinking straw
50 pcs / carton
article no. 3170008



B and C | slushy cups and flutes de luxe

Machines

D | IceKing slushy machine,
1 x 10 L container
with light display and patented magnetic
coupling flange. Advantages: no direct
contact between the beverage container
and motor, easier cleaning
230V; 460 W
Dimensions: D: 47 W: 18 H: 69 cm
article no. 7E0005



D | slushy machine, 1 x 10 L



E | slushy machine, 2 x 10 L



F | slushy machine, 3 x 10 L

E | IceKing 2 slushy machine, 2 x 10 L containers
 machine description as 7E0005,
 230V; 1,100 W
 Dimensions: D: 47 W: 36 H: 69 cm
article no. 7E0006

F | IceKing 3 slushy machine, 3 x 10 L containers
 machine description as 7E0005,
 230V; 1,300 W
 Dimensions: D: 47 W: 54 H: 69 cm
article no. 7E0007

G | Base for iced coffee machines
 designed in steel, with 4 wheels, 2 of
 which have brakes, and two additional
 shelves for syrup, cups and drinking
 straws
 Dimensions base cabinet:
 D: 54 W: 65 (103 with table) H: 88 cm
article no. 7E0022E



G | Base for slushy machines

Advertising material



H | Advertising material



H | Advertising material for iced coffee and iced chocolate
 With table displays, ceiling danglers,
 wobblers and posters, we offer a wide
 range of attractive advertising material,
 that in some cases is for free.

IceKing lemonade

Lemonade sirup

A | IceKing lemonade sirup

- Woodruff
- Cherry
- Lime
- Orange
- Peach-passion fruit
- Strawberry
- Wild Berry
- Melon
- Green Apple
- Raspberry
- Pineapple

article no. see page 67



Cups

B | IceKing lemonade cups

- with lids, also good for toppers
- 250 pcs / carton
- article no. 3170012



Drinking straws, flexible, with caps

- 250 pcs / carton
- article no. 3310013

Topper penguin

- 250 pcs / carton
- article no. 3410001

A and B | IceKing lemonade sirup, cups and toppers

Machines

C | IceKing lemonade machine

- 2 x 12 L containers;
- Patented magnetic coupling flange;
- Advantage: no direct contact between beverage container and motor; easier cleaning
- 230V; 350W
- Dimensions: D: 47 W: 36 H: 57 cm
- article no. 7E0012



C | IceKing lemonade machine

The perfect mix

Sweet treats in elegant stands: With Pick & Mix by PCO you offer the better choice!



Pick & Mix stands – the right choice for everyone

The elegant furniture has a black high quality painting and is equipped with LED lighting. The stylish black suits every interior concept perfectly and emphasizes the bright colours of the sweets. The LED lighting sets the great variety into a perfect light, which makes product pictures unnecessary. To pitch the sweet seduction to the customer the quality products speak for themselves.

In addition to the unique design the Pick & Mix stands also have a lot of practical details, that make the handling in the daily business easier. For example the stands can be closed within seconds with a roller blind, when it is not in use. In the base is a handy cabinet where sweets and bags for refilling can be stored right on the spot.

With the different sizes PCO can offer the right stand for every shop. We are very pleased to consult you individually to find the perfect solution.



The sweets are delivered directly in the boxes that are used in the stands. This makes complicated refilling obsolete. The high quality plexi lid is simply transferred from the empty to the full box and it is ready for use again. The lids are equipped with a buffer, keeping them from slamming shut.





A | Pick & Mix stand small



B | Pick & Mix stand middle

Pick & Mix stands

A | Pick & Mix stand small
 for 6 exchangeable boxes, therefore no cleaning and decanting necessary;
 with 3 LED-panels; movable stand due to 2 rollers, one lockable roller blind; integrated storage shelf
 Dimensions: D: 80 W: 48 H: 156 cm
 12 Volt; 1 Ampere; Max. 12 Watt
 Net. Weight 66 kg
article no. 7S0160

B | Pick & Mix stand middle
 for 9 exchangeable boxes, therefore no cleaning and decanting necessary;
 with 3 LED-panels; movable stand due to 2 rollers, one lockable roller blind; integrated storage shelf
 Dimensions: D: 80 W: 69 H: 156 cm
 12 Volt; 1 Ampere; Max. 12 Watt
 Net. Weight 84 kg
article no. 7S0161



C | Pick & Mix stand large



sideview

C | Pick & Mix stand large
 for 15 exchangeable boxes, therefore no cleaning and decanting necessary;
 with 3 LED-panels; movable stand due to 4 rollers, one lockable roller blind; integrated storage shelf
 Dimensions: D: 80 W: 109 H: 156 cm
 12 Volt; 1 Ampere; Max. 12 Watt
 Net. Weight 115 kg
article no. 7S0162

D | Pick & Mix stand center piece for island and peninsula
 for 15 exchangeable boxes, therefore no cleaning and decanting necessary;
 with 3 LED-panels; movable stand due to 4 rollers, one lockable roller blind; integrated storage shelf
 Dimensions: D: 80 W: 109 H: 156 cm
 12 Volt; 1 Ampere; Max. 12 Watt
 Net. Weight: 115 kg
article no. 7S0167



island

peninsula



E | Pick & Mix stand side piece for island (half-round)
 for 13 exchangeable boxes, therefore no cleaning and decanting necessary;
 with 3 LED-panels; movable stand due to 4 rollers, 2 integrated storage shelves with lockable roller blinds
 Dimensions: D: 78 W: 160 H: 140 cm
 12 Volt; 1 Ampere; Max. 12 Watt
 Net. Weight: 120 kg
article no. 7S0168

D | Pick & Mix stand center piece

E | Pick & Mix stand side piece for island (half-round)

**Pick & Mix stands
with portion control Dispensers**

To offer Jelly Beans next to the delicious fruit gums PCO has developed combined stands. They have special dispensing containers that allow easy dosage of Jelly Beans. The system is not only very hygienic but also very attractive. This is a real eye-catcher.





A | Pick & Mix stand with portion control dispenser small



B | Pick & Mix stand with portion control dispenser middle



C | Pick & Mix stand with portion control dispenser large



D | Pick & Mix stand basic, small, for 9 boxes



E | Pick & Mix stand basic, large, for 12 boxes

Pick & Mix stands with portion control dispensers

A | Pick & Mix stand small with portion control dispenser for 4 exchangeable boxes, therefore no cleaning and decanting necessary; 3 turnable dispensers, which are located on the upper part of the stand. With 4 LED-panels; movable stand due to 2 rollers, one lockable roller blind; integrated storage shelf
 Dimensions: D: 80 W: 49 H: 188 cm
 12 Volt; 1 Ampere; Max. 12 Watt
 Net. Weight: 84 kg
article no. 7S0200

B | Pick & Mix stand middle with portion control dispenser for 8 exchangeable boxes, therefore no cleaning and decanting necessary; 6 turnable dispensers, which are located on the upper part of the stand. With 4 LED-panels; movable stand due to 2 rollers, one lockable roller blind; integrated storage shelf
 Dimensions: D: 80 W: 94 H: 188 cm
 12 Volt; 1 Ampere; Max. 12 Watt
 Net. Weight: 106 kg
article no. 7S0202

C | Pick & Mix stand large with portion control dispenser for 10 exchangeable boxes, therefore no cleaning and decanting necessary; 7 turnable dispensers, which are located on the upper part of the stand. With 4 LED-panels; movable stand due to 4 rollers, one lockable roller blind; integrated storage shelf
 Dimensions: D: 80 W: 109 H: 188 cm
 12 Volt; 1 Ampere; Max. 12 Watt
 Net. Weight: 150 kg
article no. 7S0203

Pick & Mix stands basic

D | Pick & Mix stand basic for 9 boxes for self assembly
 Package dimensions: D: 73 W: 6 H: 125 cm
 Assembled dimensions: D: 68 W: 66 H: 150 cm
 Shipping weight: 19 kg
 Net. Weight: 17 kg
article no. 7S0192

E | Pick & Mix stand basic for 12 boxes for self assembly
 Package dimensions: D: 91 W: 7 H: 125 cm
 Assembled dimensions: D: 68 W: 87 H: 150 cm
 Shipping weight: 23 kg
 Net. Weight: 22 kg
article no. 7S0193

Pick & Mix sweets



Jelly Beans sweet – blueberry
3 kg carton
article no. 5530080



Jelly Beans sweet – blackberry
3 kg carton
article no. 5530083



Jelly Beans sweet – banana
2 kg box
article no. 5530100
3 kg carton
article no. 5530076



Jelly Beans sweet – peach
2 kg box
article no. 5530101
3 kg carton
article no. 5530077



Jelly Beans sweet – kiwi
2 kg box
article no. 5530102
3 kg carton
article no. 5530078



Jelly Beans sweet – strawberry
2 kg box
article no. 5530103
3 kg carton
article no. 5530079



Jelly Beans sweet – bubblegum
2 kg box
article no. 5530105
3 kg carton
article no. 5530081



Jelly Beans sweet – cherry
2 kg box
article no. 5530106
3 kg carton
article no. 5530082



Jelly Beans sweet – strawberry cheesecake
2 kg box
article no. 5530108
3 kg carton
article no. 5530084



Jelly Beans sweet – toffee
2 kg box
article no. 5530110
3 kg carton
article no. 5530086



Jelly Beans sour – mix
2 kg box
article no. 5530111
6 kg carton
article no. 5530251



Jelly Beans sour – lime
2 kg box
article no. 5530114
3 kg carton
article no. 5530090



Jelly Beans sweet – cola
2 kg box
article no. 5530120
3 kg carton
article no. 5530096

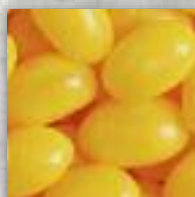

Jelly Beans sweet – passion fruit
2 kg box
article no. 5530121
3 kg carton
article no. 5530097



Jelly Beans sweet – mix
2 kg box
article no. 5530142
6 kg carton
article no. 5530252



Jelly Beans sweet – apple
2 kg box
article no. 5530260
3 kg carton
article no. 5530085



Jelly Beans sweet – tangerine
2 kg box
article no. 5530262
3 kg carton
article no. 5530261



Jelly Beans sweet – pineapple
2 kg box
article no. 5530264
3 kg carton
article no. 5530263

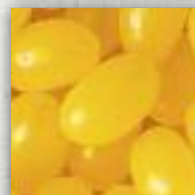

Jelly Beans sour – lemon
2 kg box
article no. 5530265
3 kg carton
article no. 5530093

Pick & Mix sweets



Smurfs
2 kg box
article no. 5530030



Cherries in Love
2 kg box
article no. 5530038



Peaches
2 kg box
article no. 5530047



Sour Soothers
2 kg box
article no. 5530031



Cola Bottles
2 kg box
article no. 5530039



Licorice Snails
2 kg box
article no. 5530049



Sour Tongues
2 kg box
article no. 5530032



Cola Soothers
2 kg box
article no. 5530040

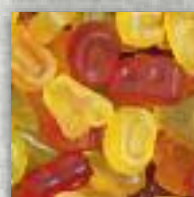

Bear School
2 kg box
article no. 5530050



Wine Gums
2 kg box
article no. 5530033



Sharks
2 kg box
article no. 5530041



Sour Black Current Rings
2 kg box
article no. 5530051



Sour Strawberries
2 kg box
article no. 5530034

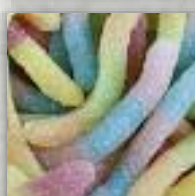

Sour Neon Worms
2 kg box
article no. 5530042

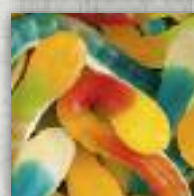

Snakes
2 kg box
article no. 5530052

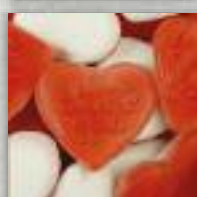

Love Hearts
2 kg box
article no. 5530035



Berries
2 kg box
article no. 5530043



M&Ms Peanuts
2 kg box
article no. 5530053

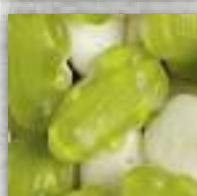

Frogs
2 kg box
article no. 5530036



Salty Licorice Pretzels
2 kg box
article no. 5530045

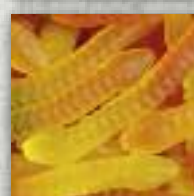

Worms
2 kg box
article no. 5530055

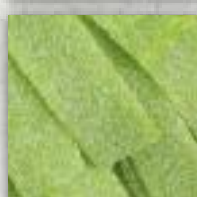

Sour Strips Apple
2 kg box
article no. 5530037



Peach Rings
2 kg box
article no. 5530046



Fried Eggs
2 kg box
article no. 5530056

Pick & Mix sweets



Dracula Teeth
2 kg box
article no. 5530057



Three-coloured Hearts
2 kg box
article no. 5530069



Strawberries with sugar coating
2 kg box
article no. 5530134



Big Bears
2 kg box
article no. 5530058



Color-Rado & Salmiak Rockies
2 kg box
article no. 5530124

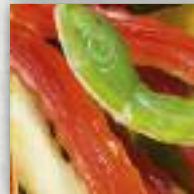

Super Snakes
2 kg box
article no. 5530136



Salmiak Rockies
2 kg box
article no. 5530063



Super Smurf
2 kg box
article no. 5530125



Rip Rolls Sour Strawberry
2 kg box
article no. 5530138



Licorice Euro-coins
2 kg box
article no. 5530064



Ahoj Candy, fizzy
2 kg box
article no. 5530127



Sour Strips Rainbow
2 kg box
article no. 5530143



Dutch Licorice, soft
2 kg box
article no. 5530065



Caramel Cubes, choco
2 kg box
article no. 5530130



Sour Strips Cola
2 kg box
article no. 5530165



Sweet Strawberries
2 kg box
article no. 5530066



Caramel Cubes, vanilla
2 kg box
article no. 5530131



Caramel Cubes, Toffee
2 kg box
article no. 5530192



Tum Tums
2 kg box
article no. 5530067



Cow Sweets classic
2 kg box
article no. 5530132



Caramel Cubes, Licorice
2 kg box
article no. 5530193



Coloured Frogs
2 kg box
article no. 5530068



Cow Sweets choco
2 kg box
article no. 5530133

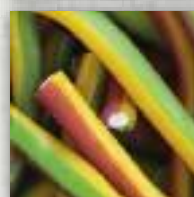

Colored Strings
1.7 kg box
article no. 5530206

Pick & Mix sweets



Licorice Strips
2 kg box
article no. 5530207



Halal Cola Bottles
2 kg box
article no. 5530194



Halal Frogs
2 kg box
article no. 5530198



Sticks
2 kg box
article no. 5530213



Halal Lobster
2 kg box
article no. 5530195



Halal Water Melon
2 kg box
article no. 5530199



Cherry Cola Bottles, fizzy
2 kg box
article no. 5530214



Halal Cobra
2 kg box
article no. 5530196



Halal Bears
2 kg box
article no. 5530200



Foam bananas
2 kg box
article no. 5530246



Halal Crocodiles
2 kg box
article no. 5530197

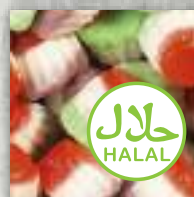

Halal Cup Cakes mini
2 kg box
article no. 5530201

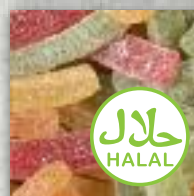

Halal Sticks
2 kg box
article no. 5530203



Halal Marshmallow Twister 4 g
500 g box
article no. 5530204



Halal Marshmallow Twister 8 g
500 g box
article no. 5530205



High quality plexi lid for Halal Pick & Mix boxes
article no. S0143-H

Pick & Mix accessories

A | Pick & Mix cups

Size 1
2,500 pcs / carton
article no. 5910035

Size 2
2,000 pcs / carton
article no. 5910036

Size 3
1,300 pcs / carton
article no. 5910037

Size 4
1,000 pcs / carton
article no. 5910040



A | Pick & Mix cups

B | Lids for Pick & Mix cups

Size 1
2,000 pcs / carton
article no. 3210022

Size 2
2,000 pcs / carton
article no. 5910042

Size 3
1,000 pcs / carton
article no. 5910043

Size 4
1,000 pcs / carton
article no. 5910044



B | Lids for Pick & Mix cups

C | Pick & Mix bag

1,000 pcs / carton
article no. 5910027

D | Pick & Mix shovel

article no. S4280210

Pick & Mix tongs

article no. S226299



C | Pick & Mix bag



D | Pick & Mix shovel and tongs

Movie Mix

The perfect mix

E | Sour Mix
 200 g
 48 pcs / carton
 article no. 5730008
 192 pcs / display
 article no. 5730010

F | Licorice Mix
 200 g
 48 pcs / carton
 article no. 5730018
 192 pcs / display
 article no. 5730020

G | Halal Mix
 200 g
 48 pcs / carton
 article no. 5730023
 192 pcs / display
 article no. 5730025

H | Foam Mix
 200 g
 48 pcs / carton
 article no. 5730013
 192 pcs / display
 article no. 5730015

I | Coloured Mix
 200 g
 48 pcs / carton
 article no. 5730003
 192 pcs / display
 article no. 5730005

J | Display for Movie Mix
 Dimensions: D:27 W:30 H:43 cm
 article no. 7S0043

Turntable for Display 7S0043
 with PCO mirror plate
 article no. 7S0042



E | Sour Mix



F | Licorice Mix



G | Halal Mix



H | Foam Mix



I | Coloured Mix



J | Display for Movie Mix

Confectionary

You will receive our Confectionary in many fine varieties. On request we provide the high-quality jars with your personal design on the label.



Amarettini
20 jars of 45 g
article no. 5700126



Peanuts, roasted and salted
20 jars of 150 g
article no. 5700121



Salty Licorice Pretzels
20 jars of 150 g
article no. 5700105



Berries
20 jars of 175 g
article no. 5700107



Peanuts, sugar-coated
20 jars of 150 g
article no. 5700125



Licorice Snails
20 jars of 150 g
article no. 5700104



Choco Popcorn with whole milk chocolate
20 jars of 75 g
article no. 8260020



Peanuts, wasabi
20 jars of 100 g
article no. 5700120



Almonds, roasted and salted
20 jars of 150 g
article no. 5700124



Choco Popcorn with white chocolate
20 jars of 75 g
article no. 8260022



Raspberries, freeze-dried, chocolate coated
20 jars of 150 g
article no. 5700117



Almonds, chocolate coated, truffle dusted
20 jars of 150 g
article no. 5700115



Choco Popcorn with dark chocolate
20 jars of 75 g
article no. 8260021



Hombre Nuts, Paprika
20 jars of 100 g
article no. 5700119



Almonds, chocolate coated, white dusted
20 jars of 150 g
article no. 5700114



Cola Bottles
20 jars of 175 g
article no. 5700103



Jelly Beans, sour mix
20 jars of 200 g
article no. 5700110



M&Ms Peanuts
20 jars of 175 g
article no. 5700116



Cola Bottles, fizzy
20 jars of 175 g
article no. 5700109



Jelly Beans, sweet mix
20 jars of 200 g
article no. 5700111



Nut and Fruit Mix, chocolate coated
20 jars of 150 g
article no. 5700113



Color-Rado & Salmiak Rockies
20 jars of 175 g
article no. 5700108



Cherries, freeze-dried, chocolate coated
20 jars of 150 g
article no. 5700118



Sour Neon Worms
20 jars of 175 g
article no. 5700101

A good idea

Starting from a purchase order with two sorted boxes we print at no extra cost your logo or company name on the labels.



Chocolate Lentils, peppermint
20 jars of 200 g
article no. 5700112



Werther's Original
20 jars of 90 g
article no. 5700127



Halal Sticks
20 jars of 150 g
article no. 5700155



Smurfs
20 jars of 175 g
article no. 5700106



Chocolate Lentils, mini
20 jars of 200 g
article no. 5700128



Halal Cup Cakes, mini
20 jars of 150 g
article no. 5700153



Nuts & Raisins
20 jars of 150 g
article no. 5700122



Caramel Cubes, Toffee
20 jars of 150 g
article no. 5700130



Halal Cola Bottles
20 jars of 150 g
article no. 5700152



Nuts & Raisins "extra class"
20 jars of 150 g
article no. 5700123



Caramel Cubes, choco
20 jars of 150 g
article no. 5700131



Halal Bears
20 jars of 150 g
article no. 5700154



Wine Gums
20 jars of 175 g
article no. 5700102



Halal Marshmallow Twister
20 jars of 50 g
article no. 5700156



Halal Water Melon
20 jars of 150 g
article no. 5700150



Sugar tongs (1 pc)
article no. S1019

Salver (1 pc)
article no. S1020

Set
consisting of two tongs
and one salver
article no. S1020



Display for Confectionary
inside mirrored
Dimensions: D:27 W:30 H:43 cm
article no. 7S0043

Turntable for Display 7S0043
article no. 7S0042

Lollipops – taste like fun

Original Gourmet™ Lollipops are the largest gourmet pops sold, with bold taste and bright colors. They really stand out from all the rest. The Gourmet Lollipops are a delight that has a plastic stick and will not get soggy like other lollipops often do. We also pride ourselves on the wide variety of flavors we offer because they are a great treat for everyone in the family.

A | Lollipop floor stand

large stand holding 272 Lollipops
+ 208 Lollipops for refill,
mixed flavours
article no. 5530151
empty stand
article no. 7S0171

B | Lollipop counter display

stand holding 70 Lollipops
+ 50 Lollipops for refill,
mixed flavours
article no. 5530152
empty display
article no. 7S0172

C | Lollipops refill box

with 120 pieces
carton with 2 bags of 60 pieces –
mixed flavours
article no. 5530150



A | Lollipop floor stand



B | Lollipop counter display



The most popular snacks for the retail trade

Fresh Popcorn, Nachos and Dips have quickly established themselves as the most popular cinema snacks. These are not only made for Cinemas, but also a delight to go or at home. This range is complemented with our durable Cotton Candy and selected organic products.



Popcorn, Nachos, Cotton Candy

Crunchy Popcorn

That is temptation de luxe. Exquisitely delicate Popcorn in the flavors milk chocolate, white chocolate, karamel, winter wonderland, forest fruit strawberry and coconut caramel, offering a refined taste experience. The delicacy is delivered in bags or reusable cups. This keeps the Crunchy Popcorn fresh and irresistibly delicious for longer.

Always up to date: specialties in unique packaging

We are also pleased to present to you our specialties Cinema Popcorn, Toffee Popcorn, Choco Popcorn and Premium Choco Popcorn, as well as Cotton Candy, in attractive special designs. Currently Vicky, and Maya the Bee are promoting our products, making them even more attractive.

Microwave Popcorn

Our Pop'Box offers fresh Popcorn fun out of the microwave and impresses with its unique and patented folding system. The box that is initially folded turns into a large folding box by pulling two tabs. In the microwave, this fills in a few minutes with fresh popcorn.

Fun-Kicker products

Soccer is one of the world's most popular sports. With our Fun Kicker product line there is the perfect snack for all those who enjoy playing or those who would rather watch. Whether Popcorn or Cotton Candy, at the sportsground or in a television armchair: Fun-Kicker offers high-quality products in sports packaging.

Organic range

The organic range of PCO currently includes organic Popcorn, organic Microwave Popcorn and organic Cotton Candy. All products feature the organic seal. For the production e.g. of Poppy Organic Popcorn, we use organically grown corn in addition to pure organic raw cane sugar. All our other ingredients are likewise organically grown.

Nachos & Dips

In cinemas they have become indispensable: delicious, spicy Nachos & Dips. For the requirements of retail we offer the popular products and also perfectly fitting sales solutions – whether display cartons or attractive displays.

Durable Cotton Candy

Cotton Candy is popular at all funfairs – but has to be eaten immediately. PCO can provide durable Cotton Candy in cups for the use at home. You can get our Cotton Candy in various flavors and packagings.

Private Label

Whether for Popcorn, Nachos or Cotton Candy, we also produce your individual designs.



Popcorn Company: finest Popcorn- specialites



**A | Toffee Popcorn
in cups**
36 x 100 g / carton
article no. 8240048
144 x 100 g / display
article no. 8240050

**B | Choco Popcorn
in cups**
24 x 70 g / carton
article no. 8250037
192 x 70 g / display
article no. 8250039
36 x 170 g / carton
article no. 8250033
144 x 170 g / display
article no. 8250035

A | Popcorn Company: Toffee Popcorn



B | Popcorn Company: Choco Popcorn

Pop'Box: Popcorn for the microwave

Our Pop'Box offers fresh Popcorn fun out of the microwave and convinces with the unique folding system. By pulling the two straps, the initially folded box turns out to be a large folding box. In the microwave it fills within a few minutes with fresh salty or sweet popcorn.

A | Popcorn for the microwave:

Pop'Box, sweet

36 x 100 g / carton

article no. 8410051

432 x 100 g / display

article no. 8410055

12 x 3 x 100 g / carton

article no. 8410050

136 x 3 x 100 g / display

article no. 8410053



A | Pop'Box, Popcorn for the microwave, sweet

POP'BOX

How it works:



A | Popcorn for the microwave, Pop'Box in trays, sweet



B | Popcorn for the microwave:
Pop'Box, salty
 36 x 100 g / carton
 article no. 8420051
 432 x 100 g / display
article no. 8420055
 12 x 3 x 100 g / carton
article no. 8420050
 136 x 3 x 100 g / display
article no. 8420053



B | Pop'Box, Popcorn for the microwave, salty



B | Popcorn for the microwave, Pop'Box in trays, salty

sweetened with pure sugar ✓
free from artificial sweeteners ✓
without diacetyl ✓
patented folding box ✓
with viewing slits ✓

Premium Choco Popcorn

Finest Toffee Popcorn covered in delicate chocolate – no need to win people over.

A | Popcorn with pure chocolate, in bags

24 x 130 g / carton
article no. 8260105

Popcorn with white chocolate, in bags

24 x 130 g / carton
article no. 8260107

Popcorn, with sweet bitter chocolate, in bags

24 x 130 g / carton
article no. 8260109

Toffee Popcorn, in bags

24 x 75 g / carton
article no. 8240042



B | Counter Display

sent for free with the first order of articles under point A, if desired
1 pc
article no. 6110027

A | Popcorn Varieties



B | Counter Display





C | Premium Choco Popcorn



Premium Choco Popcorn in cups

- C | Premium Choco Popcorn in cups
- 18 x 125 g / carton
- article no. **8260002**
- 45 x 125 g / carton
- article no. **8260004**
- 135 x 125 g / display
- article no. **8260005**

Free Shelf Wobbler delivered with your first order, on request.

Confectionary Premium Choco Popcorn



D | Choco Popcorn with milk chocolate

- D | Choco Popcorn with milk chocolate
- 20 jars à 75 g
- article no. **826020**



E | Choco Popcorn with dark chocolate

- E | Choco Popcorn with dark chocolate
- 20 Tiegel à 75 g
- article no. **8260021**



F | Choco Popcorn with white chocolate

- F | Choco Popcorn with white chocolate
- 20 Tiegel à 75 g
- article no. **8260022**

Please find more Confectionary on page 88.



A good idea

Starting from a purchase order with two sorted boxes we print at no extra cost your logo or company name on the labels.

Crunchy Popcorn

New and extra delicious in bags or cups: Crunchy Popcorn. Chocolate lovers can't help falling in love with crunchy Popcorn covered with milk oder white chocolate. And simply nobody can resist the new fruity flavours: Strawberry, Forest Fruit and Coconut Caramel.

The range of attractive bags is complemented by Kettle Popcorn Caramel and Winter Wonderland.

A | Crunchy Popcorn in bags

Milk Chocolate

24 x 125 g bags / carton
article no. 8260136

White Chocolate

24 x 125 g bags / carton
article no. 8260140

Winter Wonderland

16 x 50 g bags / carton
article no. 8150009

Karamell

16 x 50 g bags / carton
article no. 8150010

Cocnut Caramel

24 x 75 g bags / carton
article no. 8220009

Forest Fruit

16 x 100 g bags / carton
article no. 8210011

Strawberry

16 x 100 g bags / carton
article no. 8220013



A | Popcorn bags

B | Crunchy Popcorn in cups
Milk Chocolate
 18 x 125 g cups / carton
 article no. 8260138

White Chocolate
 18 x 125 g cups / carton
 article no. 8260142

Coconut Caramel
 40 x 125 g cups / carton
 article no. 8220017

Forest Fruit
 40 x 125 g cups / carton
 article no. 8210018

Strawberry
 40 x 125 g cups / carton
 article no. 8220019



B | Popcorn cubs

The finest specialty Popcorn

A | Toffee Popcorn in bags

30 x 100 g / carton
 article no. 8240007
 150 x 100 g / display
 article no. 824000



A | Toffee Popcorn

B | Poppy Toffee Popcorn in tubs

18 x 200 g / carton
 article no. 8240020
 40 x 200 g / carton
 article no. 8240021
 99 x 200 g / display
 article no. 8240022



B | Poppy Toffee Popcorn

C | Poppy Popcorn Mix

70 g Choco + 50 g Toffee +
 30 g Cinema Popcorn
 8 x 3 x 0.5 L cups / carton
 article no. 8280043
 64 x 3 x 0.5 L cups / display
 article no. 8280033



C | Poppy Popcorn Mix

D | Party Popcorn in tubs

24 x 300 g / carton
 article no. 8110051
 64 x 300 g / display
 article no. 8110052
 144 x 300 g / palette
 article no. 8110053



D | Party Popcorn

Cinema Popcorn

E | Cinema Popcorn in bags, sweet

21 x 100 g / carton
 article no. 8110008
 126 x 100 g / display
 article no. 8110009
 12 x 200 g / carton
 article no. 8110018
 72 x 200 g / display
 article no. 8110019
 40 x 300 g / carton
 article no. 8110027



E | Cinema Popcorn, sweet



- F | Cinema Popcorn in tubs, sweet**
 30 x 125 g / carton
article no. 8110041
 117 x 125 g / display
article no. 8110043
 16 x 300 g / carton
article no. 8110046
 24 x 300 g / carton
article no. 8110047
 64 x 300 g / display
article no. 8110048
 144 x 300 g / palette
article no. 8110049

F | Cinema Popcorn, sweet



- G | Cinema Popcorn in bags, salty**
 21 x 75 g / carton
article no. 8130004
 126 x 75 g / display
article no. 8130005
 18 x 100 g / carton
article no. 8180037
 40 x 200 g / carton
article no. 8130007

G | Cinema Popcorn, salty

Season Snacks

- H | Halloween pumpkin with Popcorn, LED light included**
 12 x 10 x 10 g / carton
article no. 8120087

Halloween pumpkin empty, LED light included
 12 pcs / carton
article no. 5940005



- I | Halloween Popcorn in tubs**
 16 x 300 g / carton
article no. 8120052
 24 x 300 g / carton
article no. 8120053
 64 x 300 g / display
article no. 8120054

H | Halloween Popcorn in pumpkins

I | Halloween Popcorn

A | Halloween Popcorn in tubs
 40 x 600 g / display
 article no. 8120083
 88 x 600 g / palette
 article no. 8120084



A | Halloween Popcorn

B | Halloween Cotton Candy in cups
 40 x 0.75 L / carton
 article no. 8320011
 160 x 0.75 L / display
 article no. 8320012



B | Halloween Cotton Candy

C | X-Mas Choco Popcorn in IML-cups
 24 x 70 g / carton
 article no. 8250022
 192 x 70 g / display
 article no. 8250023



C | X-Mas Choco Popcorn

D | X-Mas Choco Popcorn in cups
 36 x 170 g / carton
 article no. 8250005
 144 x 170 g / display
 article no. 8250006



D | X-Mas Choco Popcorn

E | Christmas tree Popcorn, LED light included
 12 x 10 x 10 g / carton
 article no. 8110110



E | Christmas tree Popcorn

Christmas tree Popcorn
 12 x 10 x 10 g / carton
 article no. 8110114

Christmas tree empty, LED light included
 12 pcs / carton
 article no. 5940011

F | SnowBall Cotton Candy in cups
 40 x 0.75 L / carton
 article no. 8310034
 160 x 0.75 L / display
 article no. 8310035



F | SnowBall Cotton Candy

G | Easter Popcorn in tubs
 16 x 300 g / carton
 article no. 8110062
 64 x 300 g / display
 article no. 8110063



G | Easter Popcorn

H | Happy Easter Cotton Candy in cups
 40 x 0.75 L / carton
 article no. 8310027
 160 x 0.75 L / display
 article no. 8310028



H | Happy Easter Cotton Candy



I | Easter egg with Popcorn or easter egg, empty

I | Easter egg with Popcorn, including LED-light
12 x 14 x 10 g / carton
article no. 8110105

Easter egg with Popcorn
60 x 14 x 10 g / display
article no. 8110107

Easter egg empty, including LED-light
12 pcs / carton
article no. 5940012

Fun-Kicker: for all soccer fans

Our soccer-style products add the perfect touch to every soccer evening in front of the TV or an afternoon on the pitch.

J | Fun-Kicker Toffee Popcorn, in cups
36 x 100 g / carton
article no. 8240017
144 x 100 g / display
article no. 8240018

K | Fun-Kicker Cinema Popcorn, in bags
21 x 100 g / carton
article no. 8110013
126 x 100 g / display
article no. 8110014
12 x 200 g / carton
article no. 8110021
72 x 200 g / display
article no. 8110022
40 x 300 g / carton
article no. 8110031
80 x 300 g / display
article no. 8110032

L | Fun-Kicker Cinema Popcorn, in tubs
40 x 600 g / display
article no. 8110086
88 x 600 g / palette
article no. 8110087

M | Fun-Kicker Cotton Candy, in cups
24 x 0.5 L / tray
article no. 8310059
240 x 0.5 L / display
article no. 8310061

N | Fun-Kicker Cotton Candy, 3-pack, in cups
8 x 3 x 0.5 L / tray
article no. 8310060
80 x 3 x 0.5 L / display
article no. 8310063



J | Fun-Kicker Toffee Popcorn



K | Fun-Kicker Cinema Popcorn



L | Fun-Kicker Cinema Popcorn



M | Fun-Kicker Cinema Popcorn



N | Fun-Kicker Cotton Candy, 3-pack

Vic, the Viking: Popcorn and Cotton Candy

Toffee Popcorn and Choco Popcorn in IML cups are our Popcorn classics. Cinema Popcorn in attractive 300 g and 600 g buckets is the perfect way to create that cinema atmosphere at home, and our long-lasting Cotton Candy rounds off the range of products.



A | Vic the Viking Toffee Popcorn



B | Vic the Viking Choco Popcorn

A | Vic the Viking Toffee Popcorn, in cups

40 x 75 g / carton
article no. 8290138
 160 x 75 g / display
article no. 8290139

B | Vic the Viking Choco Popcorn, in cups

40 x 100 g / carton
article no. 8290142
 160 x 100 g / display
article no. 8290143

C | Vic the Viking Cinema Popcorn, in tubs, sweet

16 x 300 g / carton
article no. 8190138
 24 x 300 g / carton
article no. 8190139
 64 x 300 g / display
article no. 8190140
 40 x 600 g / display
article no. 8190135
 88 x 600 g / palette
article no. 8190136



C | Vic the Viking Cinema Popcorn

D | Vic the Viking Cotton Candy, in cups

24 x 0.5 L / tray
article no. 8390098
 240 x 0.5 L / display
article no. 8390099
 40 x 0.75 L / carton
article no. 8390094
 160 x 0.75 L / display
article no. 8390095



D | Vic the Viking Cotton Candy



E | Maya Toffee Popcorn



F | Maya Choco Popcorn

Maya, the Bee: Popcorn and Cotton Candy

E | Maya, the Bee Toffee Popcorn, in tubs

40 x 75 g / carton
 article no. 8290163
 160 x 75 g / display
 article no. 8290164

F | Maya, the Bee Choco Popcorn in tubs

40 x 100 g / carton
 article no. 8290167
 160 x 100 g / display
 article no. 8290168

G | Maya, the Bee Cinema Popcorn, in tubs, sweet

16 x 300 g / carton
 article no. 8190174
 24 x 300 g / carton
 article no. 8190175
 64 x 300 g / display
 article no. 8190176
 40 x 600 g / display
 article no. 8190171
 88 x 600 g / pallette
 article no. 8190172

H | Maya, the Bee Cotton Candy, in cups

24 x 0.5 L / tray
 article no. 8390107
 240 x 0.5 L / display
 article no. 8390110
 40 x 0.75 L / carton
 article no. 8390102
 160 x 0.75 L / display
 article no. 8390104

I | Maya, the Bee Cotton Candy, 3-pack, in cups

8 x 3 x 0.5 L / carton
 article no. 8390108
 80 x 3 x 0.5 L / display
 article no. 8390112



G | Maya Cinema Popcorn



H | Maya Cotton Candy



I | Maya Cotton Candy, 3-pack

Durable Cotton Candy

Cotton Candy is always a hit at fairgrounds – but has to be eaten straightaway. With PCO you get fresh, durable Cotton Candy in cups and tubs to take away.

A | Sweet Balloon Cotton Candy, in cups
 24 x 0.5 L / tray
 article no. 8310067
 240 x 0.5 L / display
 article no. 8310069



A | Sweet Balloon Cotton Candy



B | Sweet Balloon Cotton Candy

B | Sweet Balloon Cotton Candy, 3-pack, in cups
 8 x 3 x 0.5 L / tray
 article no. 8310068
 80 x 3 x 0.5 L / display
 article no. 8310071

C | Sweet Balloon Cotton Candy, in cups
 40 x 0.75 L / carton
 article no. 8310075
 160 x 0.75 L / display
 article no. 8310077



C | Sweet Balloon Cotton Candy



D | Vanilla Cotton Candy

D | Vanilla Cotton Candy, in tubs
 36 x 1 L / carton
 article no. 8310056

E | Sweet Balloon Cotton Candy, in tubs
 16 x 130 g / tray
 article no. 8310082
 64 x 130 g / display
 article no. 8310081



E | Sweet Balloon Cotton Candy

F | Sour Apple Cotton Candy, in cups
 40 x 0.75 L / carton
 article no. 8320004
 160 x 0.75 L / display
 article no. 8320005



F | Sour Apple Cotton Candy



G | Maya Organic Popcorn



H | Maya Organic Cotton Candy

Organic range

For top-grade organic quality PCO offers organic Popcorn, organic Microwave Popcorn and organic Cotton Candy. You can give your customers fun snacks made from certified organic ingredients

G | Maya Organic Popcorn, in cups
40 x 45 g / carton
article no. 8890016
160 x 45 g / Display
article no. 8890018

H | Maya Organic Cotton Candy, in cups
40 x 0,75 L / carton
article no. 8890020
160 x 0,75 L / Display
article no. 8890022

I | Poppy Organic Popcorn, in bags
21 x 75 g / carton
article no. 8830002
126 x 75 g / display
article no. 8830003

J | Poppy Organic Cotton Candy, in cups
24 x 0.5 L / carton
article no. 8860002
192 x 0.5 L / display
article no. 8860003

K | Poppy Organic Microwave Popcorn, sweet
36 x 100 g / carton
article no. 8850003
264 x 100 g / display
article no. 8850005

L | Poppy Organic Microwave Popcorn, salty
36 x 100 g / carton
article no. 8850013
264 x 100 g / display
article no. 8850015



I | Poppy Organic Popcorn



J | Poppy Organic Cotton Candy



K | Poppy Organic Microwave Popcorn, sweet



L | Poppy Organic Microwave Popcorn, salty

Nachos & Dips: simply delicious

A | Hombre Nachos & Dips

75 g Hombre Nachos +
90 g Hombre **Salsa-Dip spicy**
24 cups / carton
article no. 8510011
168 cups / display
article no. 8510012

75 g Hombre Nachos +
90 g Hombre **Guacamole**
24 cups / carton
article no. 8510019
168 cups / display
article no. 8510020

75 g Hombre Nachos +
90 g Hombre **Sour-Cream**
24 cups / carton
article no. 8510023
168 cups / display
article no. 8510024

75 g Hombre Nachos +
90 g Hombre **Cheese-Dip**
24 cups / carton
article no. 8510015
168 cups / display
article no. 8510016

24 cups assorted / carton
article no. 8510026

168 cups assorted / display
article no. 8510027

B | Hombre Nachos Classic

20 x 125 g bags / carton
article no. 2110021

C | Hombre Nachos Barbecue

20 x 125 g bags / carton
article no. 2110003

D | Hombre Nachos Paprika-Chili

20 x 125 g bags / carton
article no. 2110043

E | Hombre Dips

for packaging units and order numbers:
see Nachos & Dips, page 46

F | Hombre Dips in display carton

4 x 6 portion cups / carton
article no. 2120034

G | Ricos Cheese-Dip for microwaves

12 x 4 x 99 g portion cups / carton
article no. 2120015



A | Hombre Nachos & Dips



B | Hombre Nachos Classic

C | Hombre Nachos Barbecue

D | Hombre Nachos Paprika-Chili



E | Salsa-Dip spicy and hot, Guacamole, Sour-Cream and Cheese-Dip



F | Display carton, mixed



G | Ricos Cheese-Dip for microwaves



H | Hombre Nacho-Party-Sonne
 2 x 150 g Nachos Barbecue +
 3 x 90 g Dips
(Salsa-Dip, Cheese-Dip, Sour-Cream)
 10 pcs / carton
 article no. 8510064

Real Cinema Feeling at Home

Hombre Nachos & Dip not only taste like cinema – it feels like it. Perforation and carton flap allow to convert the box into a real nacho tray in no time. And this is how to do it:

1. Remove the foil and open the box along the perforation.
2. In the box you will find a bag of crunchy Nachos and the Dip of your choice.
3. On the side of the box you will find a carton flap to unfold for the Dip. Set the open Dip in the side flap.
4. For perfect enjoyment, open the bag of Nachos and fill them into the open box.
5. Now you can sit back, relax and enjoy.

H | Hombre Nacho-Party-Sonne



I | Hombre Nachos and Dip Box
 100 g Hombre Nachos Paprika-Chili +
 90 g **Hombre Salsa-Dip**
 12 boxes / carton
 article no. 8510045
 96 boxes / display
 article no. 8510047

100 g Hombre Nachos Paprika-Chili +
 90 g **Hombre Cheese-Dip**
 12 boxes / carton
 article no. 8510049
 96 boxes / display
 article no. 8510051

100 g Hombre Nachos Paprika-Chili +
 90 g **Hombre Sour-Cream**
 12 boxes / carton
 article no. 8510053
 96 boxes / display
 article no. 8510055

Here is how it works:



I | Hombre Nachos and Dip Box

Private Label

You want Popcorn for the microwave in your own design? Not a problem.



We get rid of any size of thirst

Cold soft drinks, icy slushy, hot coffee or tea, branded cups, neutral cups: from PCO you get the right cup for every thirst.



IML-cups: What is IML?

The term "in-mold labeling" is derived from the production technology: A photo quality printed label of polypropylene (PP) is placed in a mold, which already has the shape of the end product – for example a drinking cup. Subsequently, the liquid PP is injected into the mold. There the plastic melts with the label and takes the shape of the mold. Result: label and packaging form a single entity. The outer surface structure of the cup can be smooth or have a fine structure. The PCO Group offers this cup and cover in different variants:

A | IML-cup, 1.0 L

IML-cup, 0.75 L

IML-cup, 0.5 L

IML-cup, 0.3 L



A | IML-cups

B | Lids are available

- in different sizes
- in different colors
- with and without topper cutout
- with and without hole for a straw



B | Lids

Movie promotions

For current blockbusters you will find our regular quality IML-cups. The cups are printed in photo quality and are available in different sizes, depending on the movie. For many animated movies the cups are additionally enhanced with funny toppers that are attached to the lid.

For more information on cups with current movie themes, see the chapter about movie promotions starting on page 119.



Private Label

You have a need for reusable drinking cups or unique packaging? We are happy to produce for you exclusive IML-cups or drinking cups made of cardboard according to your individual designs. The printing is done in a minimum print run of 10,000 (IML-cups) and/or 50,000 (cardboard cups) pieces per size and design.



**Coca-Cola and Pepsi
drinking cups**

A | Drinking cup Coca-Cola, 0.2 L
2,000 pcs / carton
article no. 3110020

Drinking cup Coca-Cola, 0.3 L
2,000 pcs / carton
article no. 3110001

Drinking cup Coca-Cola, 0.4 L
1,000 pcs / carton
article no. 3110002

Drinking cup Coca-Cola, 0.5 L
1,000 pcs / carton
article no. 3110003

Drinking cup Coca-Cola, 0.75 L
500 pcs / carton
article no. 3110004

Drinking cup Coca-Cola, 1.0 L
500 pcs / carton
article no. 3110005

Drinking cup Coca-Cola, 1.5 L
360 pcs / carton
article no. 3110006



A | Drinking cups Coca-Cola

B | Drinking cup Pepsi, 0.2 L
2,500 pcs / carton
article no. 3120010

Drinking cup Pepsi, 0.3 L
2,000 pcs / carton
article no. 3120001

Drinking cup Pepsi, 0.4 L
1,000 pcs / carton
article no. 3120003

Drinking cup Pepsi, 0.5 L
1,000 pcs / carton
article no. 3120004

Drinking cup Pepsi, 0.75 L
500 pcs / carton
article no. 3120005

Drinking cup Pepsi, 1.0 L
500 pcs / carton
article no. 3120006

Drinking cup Pepsi, 1.5 L
360 pcs / carton
article no. 3120007



B | Drinking cups Pepsi

Lids and drinking straws

C | Lids for drinking cup 0.2 L
2,000 pcs / carton
article no. 3210011

Lids for drinking cup 0.3 L
2,000 pcs / carton
article no. 3210001

Lids for drinking cup 0,4 l / 0.5 L
1,000 pcs / carton
article no. 3210002

Lids for drinking cup 0.75 L
500 pcs / carton
article no. 3210003

Lids for drinking cup 1.0 L
1,000 pcs / carton
article no. 3210004

Lids for drinking cup 1.5 L
720 pcs / carton
article no. 3210005



C | Lids for drinking cups



D | Straws, 26.5 cm, flexible



E | Straws, 21 cm, flexible

D | Straws, 26.5 cm
flexible, with cap
250 pcs / carton
article no. 3310013

E | Straws, 21 cm
flexible
10,000 pcs / carton
article no. 3310001

F | Straws, 21 cm
rigid
12,000 pcs / carton
article no. 3310002

Straws, 25 cm
rigid
individually wrapped
2,000 pcs / carton
article no. 3310010

Straws, 27 cm
rigid
10,000 pcs / carton
article no. 3310005



F | Straws, rigid



G | Stirrers

G | Stirrers
1,000 pcs / carton
article no. 3910028

Wooden stirrers
500 pcs / carton
article no. 3910045

Transparent drinking cups and mugs

A | Drinking cups, clear, 0.2 L
3,000 pcs / carton
article no. 3130004

Drinking cups, clear, 0.3 L
2,500 pcs / carton
article no. 3130005

Drinking cups, clear, 0.4 L
1,400 pcs / carton
article no. 3130006

Drinking cups, clear, 0.5 L
1,300 pcs / carton
article no. 3130007



A | Drinking cups, clear

B | Plastic wine glasses, 0.2 L
400 pcs / carton
article no. 3130017

C | Plastic champagne glasses, 0.1 L
500 pcs / carton
article no. 3130012

D | Mug Touch
48 pcs / carton
article no. 3140022

E | Mug Shooting Break
48 pcs / carton
article no. 3140024



B | Plastic wine glasses

C | Plastic champagne glasses



D | Mug Touch

E | Mug Shooting Break

Hot drink cups



F | Hot drink cups, double wall

F | Hot drink cups 0.2 L
double wall
500 pcs / carton
article no. 3140018

Hot drink cups 0.3 L
double wall
600 pcs / carton
article no. 3140025

Lids for
hot drink cups, 0.2 L
1,000 pcs / carton
article no. 3220004

Lids for
hot drink cups
0.3 L / 0.4 L / 0.5 L
1,000 pcs / carton
article no. 3220005



G | Hot drink cups, single wall

G | Hot drink cups, 0.2 L
single wall
1,000 pcs / carton
article no. 3140002

Hot drink cups, 0.4 L
single wall
1,000 pcs / carton
article no. 3140004



We will be pleased to send you a quote for hot drink cups in your own design.

Cup dispensers

You want to generate more orders in your counter area? No problem with the appropriate cup dispensers, that are suitable for mounting on the wall or into the counter. In addition we can offer you holders for Straws and Lids.

We are happy to put together a custom quote.



Straw dispenser

Cup dispenser installation example



Cup dispensers



Lid dispensers



Movie promotion: our pop stars

It's a known fact that nice packaging is an eye-catcher and seduces consumers more likely to buy. Our range of different packaging formats in a multitude of sizes and featuring motifs from the latest films ensures that you can respond to any customer requirements.



Meet your movie heroes at the cinema counter

With all the menu trays, IML-cups, toppers, Popcorn bags, boxes and tubs your counters will be a feast for the eyes.

Sign up for our newsletter and get information and order forms relating to all the latest blockbusters. Then you'll always be up to speed on the latest designs: www.pco-group.com



Menu-trays

Our Kids-Menu is the popular way to ensure the counter tills keep ringing. The patented Kids-Menu-Tray with matching IML-cup is only available from PCO. It has been so popular that we now produce the patented tray in four sizes – for cups of 0.3 L, 0.5 L, 0.75 L and 1.0 L. That way you cover all target groups.

Kids-Menu-Tray for 71 oz Popcorn and a cup of 0.5 L



Kids-Menu-Tray for 50 oz Popcorn and a cup of 0.3 L



Kids-Menu-Tray for 71 oz Popcorn and a cup of 0.5 L



Menu-Tray for 106 oz Popcorn and a cup of 0.75 L



Big-Menu-Tray for 155 oz Popcorn and a cup of 1 L

Top the PET bottles

You can show off our Kids Menu with PET bottles, too. A folding feature in the Kids-Menu-Tray steadies the bottle and the patented adapter attaches the topper to the PET bottle.

The new turnable adapter allows to drink without removing the topper.



Ever popular:

With our Dino Menu you have a Menu motif that you can offer your customers, whatever films are showing. Which means ... blockbusters.



Well packaged

We supply you with a wide selection of Popcorn bags, boxes, tubs and reclosable IML-tubs.

Bags are the classic type of Popcorn packaging, with a range of sizes to suit every target group.

Our folding boxes provide a more robust alternative, likewise available in different sizes. Now we offer brandnew boxes in the popcorn bag formats.

The stars of the counter are our size-5 Popcorn tubs – great for accommodating even two hands ...

As of now, we are providing metal buckets with a premium, shining print and imprint. The metal buckets hold 130 oz. and are ideal for Popcorn.

Another winning format is our deluxe 1.6 L IML-tub with its fantastic motif, its lid for preserving Popcorn freshness and the option to add a whacky topper to the packaging.



Popcorn bags and Popcorn boxes



Folding boxes



Popcorn tubs



Popcorn tins



1.6 L IML-tubs



Our IML-cup: more than just a cup!

We regularly produce high-quality IML-cups to coincide with the release of blockbusters. Printed to photo quality, the cups are available in different sizes, depending on the film, and they can of course be re-used. Just think about camping, picnics, children's birthdays ...

But what does IML actually mean? Read more on page 112 in our chapter on cups and drinking straws.



2 L Mega cup



1 L



0.3 L



0.5 L



0.75 L

Topper on top

We get pleasure out of topping our products. Many of our hit products designed for children to have cups that we have enhanced by attaching topper figurines to the lid. Guaranteed to trigger the collector's instinct!



Peanuts



Trolls



Start Trek Beyond



Secret Life of Pets



Batman v Superman

Action topper



Kung Fu Panda 3



Captain America

Premiums: love at first sight

We simply love our premiums. Beside the toppers, our product range covers irresistible products such as drinking straws with figurines, key chains, plush and much more. Here is a small selection of promotional features from our range of merchandising. To put it perfectly in scene we also provide you very stylish merchandising displays.



Key chains



Playing cards



Lunch boxes



Mugs



Straws with turnable figurines



Snapbands



Promotion display



Plush, film boxes and much more

A sophisticated ambience enhances the visitors' lasting positive impression. With the hygiene and cleaning products from PCO, you have everything wrapped up. Whether in front of or behind the scenes: We always have the right solution for you.

How to make a striking impression with your customers



Hygiene dispensers

in stainless steel design

A | Big roll dispenser

made of stable stainless steel with lockable socket screw, for big roll toilet paper up to Ø 350 mm
 Dimensions: 355 x 115 x 375 mm
article no. 7J0031
 suitable for article no. 4200001

B | Dispenser

made of ABS plastic, chrome plated with transparent slider, suitable for 2 small rolls toilet paper up to Ø 130 mm, lockable
 Dimensions: 260 x 150 x 150 mm
article no. 7J0028
 suitable for article no. 4200044

C | Paper towel dispenser

made of impact resistant, antistatic plastic, silver coated, with sensor controlled dispensing function, dispensing intervals adjustable between 1 and 5 secs, for either mains or battery operation, paper length 20-110 cm, service button makes threading paper easier and checks correct battery insertion, self-closing cylinder lock
 Dimensions: 322 x 233 x 365 mm
article no. 7K0003 / 7K0001
 suitable for
 article no. 4200007
 article no. 4200008
 article no. 4200009

D | Towel dispenser

made of stainless steel with viewing window, suitable for all folded paper towels, approx. 300-600 sheets filling volume, lockable
 Dimensions: 255 x 125 x 330 mm
article no. 7J0007
 suitable for
 article no. 4200046
 article no. 4200012

E | Soap dispenser, small

made of stainless steel
 Dimensions: 200 x 118 x 115 mm
article no. 7N0002
 suitable for
 article no. 4200024
 article no. 4200025
 article no. 4200026

F | Dispenser for toilet-seat cleaning-agent

brushed stainless steel
 Dimensions: 205 x 100 x 105 mm
article no. 7O0001
 suitable for article no. 4200042

With our dispensers for soap, towels and toilet paper, you get a complete system from one source. In simple white or smart high-grade steel, there is a suitable requirement for every environment. Of course we also offer you a wide range of suitable refill products.

In addition, you will find that we provide a wide range of the detergents which were developed especially for commercial requirements. Whether it's kettle cleaners for Popcorn machines, glass cleaners, high-grade steel care or universal cleaners, all products stand for the highest productivity and are especially hypoallergenic.



A | Big roll dispenser



B | Dispenser



C | Paper towel dispenser



D | Towel dispenser



E | Soap dispenser, small



F | Dispenser for toilet-seat cleaning-agent



G | Soap dispenser



H | Hygiene bag dispenser

G | Soap dispenser
made of stainless steel with viewing window, optionally for 950 ml cartridge or with refill container; lockable
Dimensions: 105 x 110 x 320 mm
article no. 7J0033
suitable for
article no. 4200024
article no. 4200025
article no. 4200020
article no. 4200021
article no. 4200026

Refill container
article no. 7J0025

H | Hygiene bag dispenser
verchromt für PE-Beutel-Kassetten
Maße: 135 x 95 x 32 mm
Artikelnr. 7J0020
suitable for
article no. 4300018



I | Hygiene waste bin



J | Wall mount

I | Hygiene waste bin
with swing lid, made of ABS plastic, silver painted, 8 L content, rectangular
Dimensions: 240 x 170 x 360 mm
article no. 7J0014 + 7J0015
suitable for
article no. 4300001

J | Wall mount
made of ABS plastic, silver painted, for hygiene waste bins
article no. 7J0016

in white plastic



K | Big roll dispenser



L | Dispenser

K | Big roll dispenser
made of ABS plastic, white, with viewing window, for big roll toilet paper up to Ø 320 mm, lockable
Dimensions: 360 x 130 x 370 mm
article no. 7J0001
suitable for
article no. 4200001

L | Dispenser
made of ABS plastic, white, with transparent slider, suitable for 2 small rolls toilet paper up to Ø 130 mm, lockable
Dimensions: 260 x 150 x 150 mm
article no. 7J0027
suitable for
article no. 4200044

A | Dispenser for paper towel rolls
 with centerfeed roll, made of ABS plastic, white, suitable for paper towel rolls up to Ø 245 mm, lockable
 Dimensions: 255 x 260 x 370 mm
article no. 7M0008
 suitable for article no. 4200010



A | Dispenser for paper towel rolls



B | Paper hand towel dispenser

B | Paper hand towel dispenser
 made of impact resistant, antistatic plastic, white, with sensor controlled output, dispensing intervals adjustable between 1 and 5 secs, for either mains or battery operation, paper length 20-110 cm, service button makes threading paper easier and checks correct battery insertion, self-closing cylinder lock
 Dimensions: 322 x 233 x 365 mm
article no. 7K0004 / 7K0002
 suitable for
 article no. 4200007
 article no. 4200008
 article no. 4200009

C | Towel dispenser
 made of ABS plastic, white, with viewing window, suitable for all folded paper towels, approx. 400-800 sheets filling volume, lockable
 Dimensions: 280 x 137 x 375 mm
article no. 7J0006
 suitable for
 article no. 4200046
 article no. 4200012



C | Towel dispenser



D | Soap dispenser

D | Soap dispenser
 made of ABS plastic, white, with viewing window, optionally for 950 ml cartridge or with refill container, lockable
 Dimensions: 105 x 110 x 320 mm
article no. 7J0008
 suitable for
 article no. 4200020
 article no. 4200021
 article no. 4200024
 article no. 4200025
 article no. 4200026

E | Soap dispenser with armbar
 made of ABS plastic, white, with viewing window, optionally for 950 ml cartridge or with refill container, lockable
 Dimensions: 105 x 110 x 320 mm
article no. 7J0010
 suitable for
 article no. 4200020
 article no. 4200021



E | Soap dispenser with armbar



F | Air freshener dispenser



G | Towel dispenser without cover

F | Air freshener dispenser
made of ABS plastic, white, with timer, battery operation, suitable for air freshener cans, 9 different settings. Pilot light allows function check
Dimensions: 90 x 85 x 220 mm
article no. 7J0024
suitable for
article no. 4200050
article no. 4200051

G | Towel dispenser without cover
manually operated, white, for towel rolls
Dimensions: 425 x 342 x 250 mm
article no. 7M0004
suitable for
article no. 4200007
article no. 4200008



H | Cover white



I | Cover silver

H | Cover white for towel dispenser
Dimensions: 280 x 335 x 18 mm
article no. 7M0005
suitable for article no. 7M0004

I | Cover silver for towel dispenser
Dimensions: 280 x 335 x 18 mm
article no. 7M0006
suitable for article no. 7M0004

J | Disinfection dispenser with armbar
manually operated, white, for towel rolls
Dimensions: 272 x 96 x 168 mm
article no. 7N0001
suitable for article no. 4200038



J | Disinfection dispenser with armbar



K | Hygiene bag dispenser

K | Hygiene bag dispenser
made of ABS plastic, white, for PE-bags-box
Dimensions: 135 x 95 x 32 mm
article no. 7J0019
suitable for article no. 4300018

A | Hygiene waste bin
with swing lid,
made of ABS plastic, white,
8 L content, rectangular
Dimensions: 240 x 170 x 360 mm
article no. 7J0011 + 7J0013
suitable for
article no. 4300001



A | Hygiene waste bin

B | Wall mount
made of ABS plastic,
for hygiene waste bins
article no. 7J0012



B | Wall mount

C | Waste bin
made of metal / plastic,
grey / aluminum,
Dimensions: 193 x 373 x 678 mm
article no. 7L0001



C | Waste bin

D | Wall mount
for cleaning rolls, made of sturdy,
powder coated steel, white,
for cleaning rolls up to 400 mm width
Dimensions: 430 x 210 x 400 mm
article no. 7J0017
suitable for article no. 4200013



D | Wall mount

Toilet paper

E | Large roll

2-layer, white, 400 m, 6 rolls
article no. 4200001

Small roll

2-layer, white, 400 sheets, 56 rolls
article no. 4200044

Paper towels

F | Large roll with core

2-layer, white, 138 m, 6 rolls
article no. 4200007

Large roll, crepe

1-layer, natural, 200 m, 6 rolls
article no. 4200008

Large roll, coreless

1-layer, natural, 350 m, 6 rolls
article no. 4200010

suitable for
 article no. 7K0001
 article no. 7K0002
 article no. 7K0003
 article no. 7K0004
 article no. 7M0004

G | Cleaning rolls

2-layer, white, 1,000 sheets, 2 rolls
article no. 4200013

H | Kitchen rolls

2-layer, white, 64 sheets,
 32 x 2 rolls
article no. 4200045

I | Fanfold paper Z-Folding

5,000 pcs / carton
article no. 4200012
 suitable for
 article no. 7J0006
 article no. 7J0007

J | Fanfold paper C-Folding

3,600 pcs / carton
article no. 4200046
 suitable for
 article no. 7J0006
 article no. 7J0007



E | Toilet paper rolls



F | Paper towels, large rolls



G | Cleaning rolls



H | Kitchen rolls



I | Fanfold paper Z-Folding



J | Fanfold paper C-Folding

Washing lotion

A | Washing lotion rose
 scented, 5 L / canister
article no. 4200024
 scented, 950 ml, 12 bottles
article no. 4200020
 suitable for
 article no. 7N0002
 article no. 7J0033
 article no. 7J0008
 article no. 7J0010



A | Washing lotion rose



B | Washing lotion neutral

B | Washing lotion neutral
 unscented, 5 L / canister
article no. 4200025
 unscented, 950 ml, 12 bottles
article no. 4200021
 suitable for
 article no. 7N0002
 article no. 7J0033
 article no. 7J0008
 article no. 7J0010

C | Washing lotion for disinfection
 5 L / canister
article no. 4200026
 suitable for
 article no. 7N0002
 article no. 7J0033
 article no. 7J0008



C | Washing lotion for disinfection

D | Hand disinfection Sterilium
 1 L, 10 bottles / carton
article no. 4200038
 suitable for article no. 7N0001



D | Hand disinfection Sterilium

E | Disinfectant
 400 ml, 12 bags / carton
article no. 4200042
 suitable for article no. 7O0001



E | Disinfectant



F | Air freshener cans



G | Hygiene bags

Air freshener cans

- F | Air freshener cans for air freshener dispensers 7J0024
Fresh Citrus fragrance, 6 cans
article no. 4200050
- Fresh Ocean fragrance, 6 cans
article no. 4200051

Hygiene bags

- G | Hygiene bags
from PE, 30 pcs, 50 cartons
article no. 4300018
- H | Waste bags
for hygiene bins, 16 L, 40 rolls
article no. 4300001



H | Waste bags



I | Dishwasher cleaner

Dishwashing detergents

- I | Dishwasher cleaner
Powder, 10 kg / bucket
article no. 4100034
- J | Dishwasher cleaner
for industrial machines,
10 L / canister
article no. 4100035
- K | Dishwasher cleaner tabs
160 tabs / bucket
article no. 4100051



J | Dishwasher cleaner



K | Dishwasher cleaner tabs

- L | Glass cleaning tabs
for kitchen sinks, 75 tabs / carton
article no. 4100055



L | Glass cleaning tabs

A | Rinse agent
for dishwashers, 5 L / canister
article no. 4100053



A | Rinse agent

B | Regenerating salt
for dishwashers, 2 kg / bag
article no. 4100052



B | Regenerating salt

C | Dishwashing detergent
12 x 1 L bottles
article no. 4100046



C | Dishwashing detergent

D | Heavy duty detergent
10 kg / carton
article no. 4100036



D | Heavy duty detergent

Cleaning agents

E | Toilet cleaner
12 x 1 L bottles
article no. 4100047



E | Toilet cleaner

**F | Special cleaning agent /
grease solvent**
10 L / canister
article no. 4100039



F | Cleaning agent / grease solvent

G | All-purpose cleaner
12 x 1 L bottles
article no. 4100048



G | All-purpose cleaner

H | Stainless steel cleaner
6 x 0,5 L bottles
article no. 4100076



H | Stainless steel cleaner

I | Glass cleaner
12 x 1 L bottles
article no. 4100045



I | Glass cleaner

J | Scouring cream
12 x 1 L bottles
article no. 4100049



J | Scouring cream



K | Toilet blocks



L | Urine and limescale remover

K | Toilet blocks
1 kg / can
article no. 4100037

L | Urine and limescale remover
10 L / canister
article no. 4100038



M | Sponge cloth



N | Abrasive cloth

M | Sponge cloth
18 x 19 cm, 10 pcs
article no. 4100041

N | Abrasive cloth
50 x 60 cm, 1 pc
article no. 4100065



O | Scouring sponge Glitzi



P | Disposable gloves

O | Scouring sponge Glitzi
green-yellow, 10 pcs
article no. 4100042

P | Disposable gloves
made of PE for men, 100 pcs
article no. 4100044
made of PE for ladies, 100 pcs
article no. 4100071



Q | Rubber gloves



R | Cotton gloves

Q | Rubber gloves
size M
12 pairs
article no. 4100050

R | Cotton gloves
12 pairs
article no. 4100072



S | Broom and dustpan



T | Urinal Screen

S | Broom and dustpan set
article no. 4100031

Broom
article no. 4100073

Dustpan
article no. 4100074

T | Urinal Screen
1 pc
article no. 4200030

Trash bags

A | Trash bags 16 L
450 x 520 mm, transparent,
40 x 50 pcs
article no. 4300001



A | Trash bags 16 L, transparent

B | Trash bags 30 L
490 x 600 mm, transparent,
40 x 50 pcs
article no. 4300002



B | Trash bags 30 L, transparent

C | Trash bags 70 L
575 x 1,000 mm, blue,
10 x 25 pcs
article no. 4300005



C | Trash bags 70 L, blue

D | Trash bags 70 L
370 x 250 x 850 mm, white,
9 x 40 pcs
article no. 4300007



D | Trash bags 70 L, white

E | Trash bags 120 L
700 x 1,100 mm, blue,
10 x 25 pcs
article no. 4300008



E | Trash bags 120 L, blue

F | Trash bags 140 L
600 x 250 x 1.150 mm, black,
200 pcs
article no. 4300011



F | Trash bags 140 L, black

G | Trash bags 160 L
700 x 200 x 1.100 mm, blue,
10 x 25 pcs
article no. 4300017



G | Trash bags 160 L, blue

H | Trash bags 240 L
650 x 550 x 1.350 mm, blue,
100 pcs loose
article no. 4300012



H | Trash bags 240 L, blue

Welcome to the 3rd dimension

With PCO you get new 3D Glasses for different systems. You can also take advantage of the unique cleaning service: Your used glasses will be collected, cleaned, disinfected, individually packed and sent back to you again.



3D Glasses: Welcome to the 3rd dimension

Original RealD Glasses

As an authorized RealD dealer, we can offer you original RealD Glasses:

A | Original RealD Glasses
500 pcs / carton
article no. 6390045

B | Original RealD Glasses for children
500 pcs / carton
article no. 6390046



A | Original RealD Glasses



B | Original RealD Glasses for children

Use our unique cleaning service:

We have created conditions for the professional cleaning and re-packaging of used RealD Glasses.

Collected in the movie theater, used 3D-Glasses will be picked up, transported to PCO Group in Dassow and then sorted. The number of glasses that are no longer cleanable (for example due to larger scratches on the lens) and the number that can be cleaned, is documented. In a period of four to six weeks you receive cleaned, disinfected and newly packaged glasses, returned for use in the movie theater. Only the glasses that could be cleaned are delivered back to the cinema and charged for.



C | Display for 3D Glasses
available on request for free
at ordering 3D Glasses
article no. 5920006

D | Collection container for used 3D Glasses
Floor display with insertion slots for 3D Glasses used in the movie theater
article no. 5920003

E | Carton for collecting used 3D Glasses
(not illustrated)
article no. 5920004

D | Collection container for the collection of used 3D Glasses



C | Display for 3D Glasses

Aviator 3D Glasses Simply cool!

The new Aviator 3D Glasses offer your customers something special – their own 3D Glasses for repeated use. The stylish glasses are packed in individual printed sachets. There is one version each for men and women.

A | 3D Glasses Aviator for men
incl. sachets
50 pieces / carton
article no. 6390061



B | 3D Glasses Aviator for women
incl. sachets
50 pieces / carton
article no. 6390063



Clip-on

Our 3D clip-ons will be especially appreciated by wearers of glasses among your visitors. They no longer have to wear the 3D Glasses over their own glasses. They can simply clip them on.

C | 3D-Brillen Real D Clip on
20 pieces
article no. 6390044



Your small visitors will love the child seats, because then each film is an even greater pleasure. Give them one more reason to come back to your movie theater.

Let your small customers outgrow themselves.



Child seats: Sit higher – see more

The seats are supplied in a practical stack with 38 pieces and can be stored easily. You get the booster seats in red or grey.



A | Child seats, red
38 pcs / stack
article no. 7S0013

B | Child seats, grey
38 pcs / stack
article no. 7S0035



A | Child seats, red



B | Child seats, grey

Hombre Nuts out of the warmer

Crispy coated peanuts develop their full flavor when they come directly from the warmer. And this is how you can immediately put your product in the spotlight.



The crispy delight

From PCO you get everything out of one hand. The attractive, illuminated warmer will be provided for free.

1. Warmer

The attractive, illuminated warmer is an eye catcher on your counter and only needs little space.

3. Packaging

The crispy coated nuts are served in cups with matching lids and paper napkins ...

2. Ingredients

You get Hombre Nuts in 650 g bags. This size allows you to always serve fresh Hombre Nuts.

... and ready.

A | Hombre Nuts warmer

Hombre Nuts warmer with illuminated top and heated bottom plate; filling from above, serving through a flap in the rear;
230 V; 70 W
Dimensions: D: 19 W: 23 H: 39 cm
Capacity: approx. 1,300 g Hombre Nuts / approx. 15 portions
article no. 7S0029

B | Hombre Nuts packet consisting of Hombre Nuts

12 x 650 g
Hombre Nuts cups
90 pcs
Hombre Nuts lids for cups
90 pcs
Hombre Nuts napkins
100 pcs
article no. 5510026



A | Hombre Nuts warmer



B | Hombre Nuts packet

Be up-to-date

On our website www.pco-group.com you can find more information on the product diversity of PCO. You will always find the latest information about our products and current projects available.



Be up-to-date:

1. Internet shop

Our B2B-Shop for business customers is available for more detailed product information.

www.pco-group.com

2. Newsletter

Do you want to be informed on our current projects and new products even more quickly? Then simply sign up via our website for our newsletter.

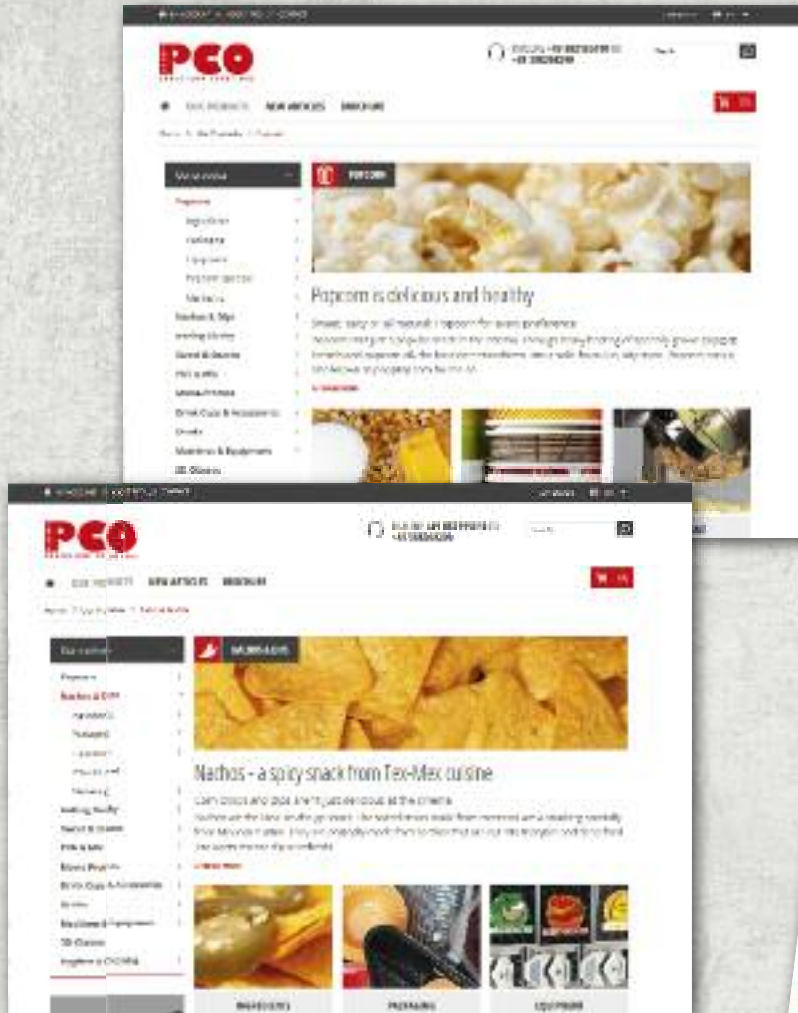

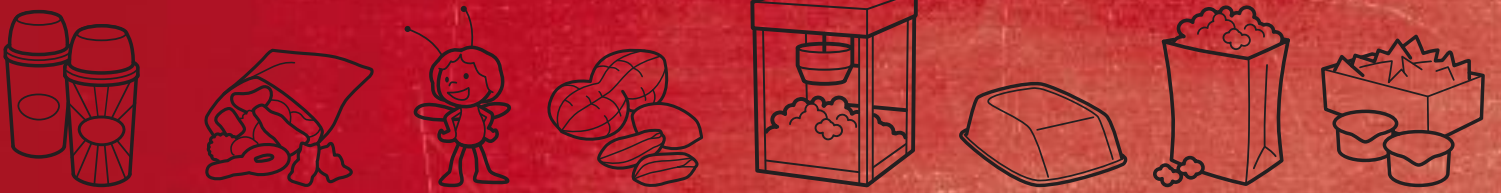
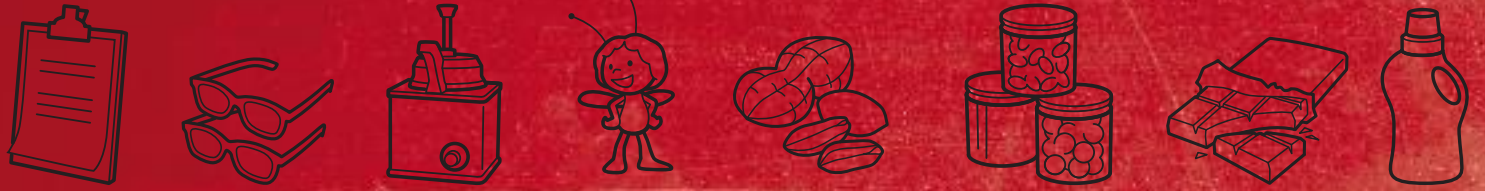
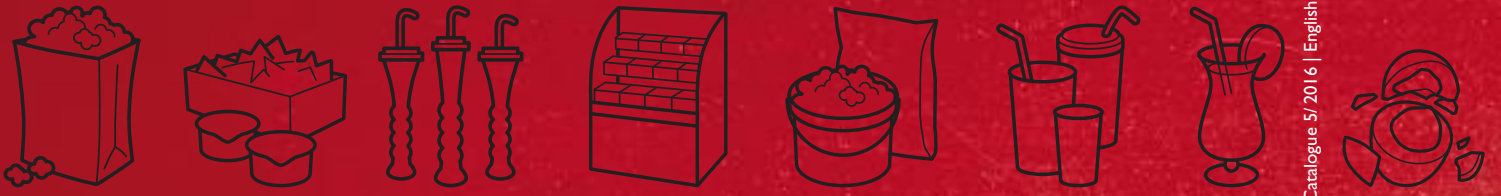

PCO Group GmbH
info@pco-group.com
www.pco-group.com

Hupfleitenweg 10
D-82467 Garmisch-P.
Telephone +49 8821 9501 0

Holmer Berg 15-17
D-23942 Dassow
Telephone +49 38826 829 0